

HOP-W19 Universal open frame mounting

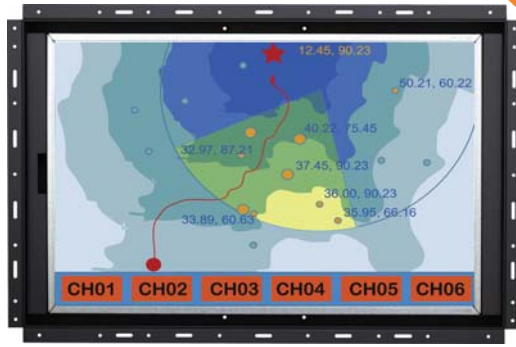

Display Benefits

- ▶ 19" widescreen LCD with high brightness 1000 cd/m²
- ▶ Green LED-backlit panel technology
- ▶ Rugged construction against external impact

Options

- 3G / HD / SD-SDI Broadcast-grade input
- MCS Multi-display control solution
- Projected Capacitive (10-point touch)
- Resistive / Capacitive (1-point touch)
- S-Video + Composite (BNC) or Audio input
- HDMI or DVI-D (either one for AV2.2 upgrade)
- MIL-type or lockable connector
- DC power : 24V / 48V / 125V / 250V
- Quad display for CCTV
- TV - Analog
- Auto / switch dimming



Basic I/O

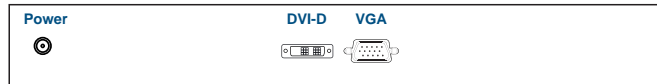

AV2.2D upgrade I/O

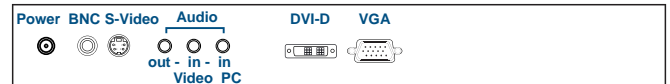

AV3.0 upgrade I/O* with advanced features

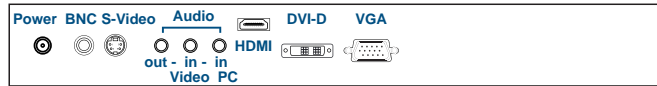

AV2.2H upgrade I/O



Specifications

LCD Panel

- Size (diagonal) : 19" Widescreen TFT
- Max resolution : 1440 x 900
- Brightness (cd/m²) : 1000
- Backlight : LED
- Colors : 16.7 M
- Contrast ratio (typ) : 1000 : 1
- Viewing angle (H/V) : 160° x 160°
- Active area (mm) : 408 x 255
- MTBF (hrs) : 50,000
- Video input : VGA or DVI-D

Speaker :

Built-in Dual Stereo Speakers 2W x 2
(Bundled with AV2.2 upgrade)

Power Input :

Auto-sensing 100 to 240VAC, 50 / 60Hz

Power Consumption

- Screen on : Max. 35W
- Power saving mode : Max. 4W
- Power button on : Max. 1W

Environmental

- Operating temperature : 0 to 55°C degree
- Storage temperature : -20 to 60°C degree
- Operating humidity : 20~90%, non-condensing
- Storage humidity : 5 ~90%, non-condensing
- Operating altitude : 16,000 ft
- Non-operating altitude : 40,000 ft
- Shock : 10G acceleration (11ms duration)
- Vibration : 5~500Hz 1G RMS random vibration

Casing Color :

Black (RAL 9005)

Mounting :

Universal mount / VESA mount

Regulatory

- Safety : FCC & CE certified
- Environmental : RoHS2 & REACH compliant

Weight

- Net : 5 kgs / 11 lbs
- Gross : 10 kgs / 22 lbs

Dimensions

- Product : 505.5 x 59.6 x 335.1 mm / 19.9 x 2.3 x 13.2 inch
- Packing : 662 x 115 x 533 mm / 26.1 x 4.5 x 21 inch

Diagrams (mm)

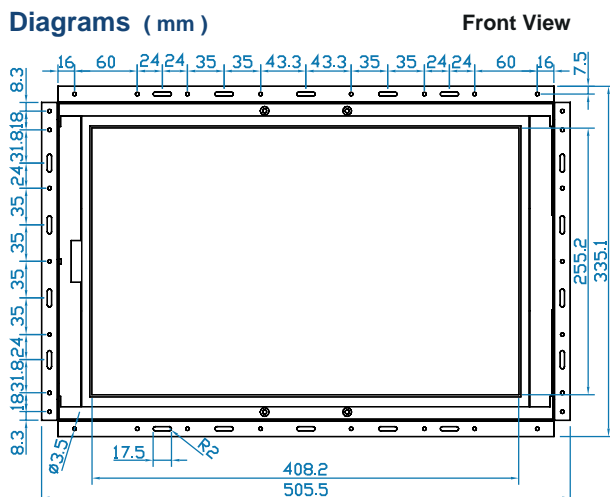

Side View

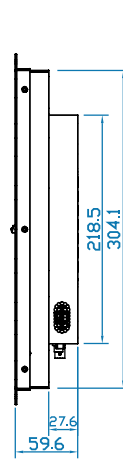

Rear View

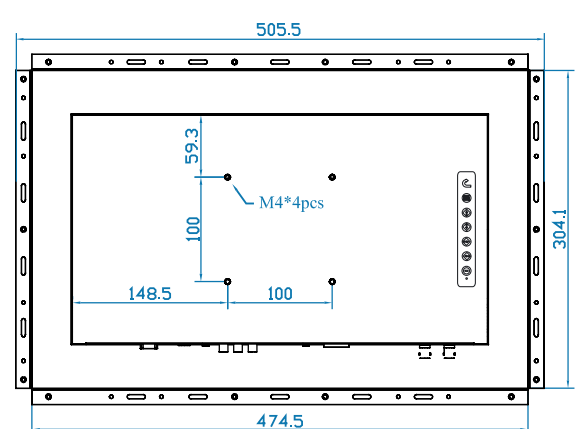

**Dimension will be changed if Multi-touch required