

4K UHD



### Key Benefits

- ▶ 43" LED, 3840 x 2160 native UHD resolution
- ▶ 1920 x 1080 & 1920 x 1200 resolution support
- ▶ 1.07 billion colors ( 10-bit ) / 350 cd/m<sup>2</sup> brightness
- ▶ PIP Sub-screen & PBP Dual-screen viewing efficiency
- ▶ Display port 1.2 + HDMI 1.4 + HDMI 2.0 video input
- ▶ Video decoding capability up to 1080p ( option )
- ▶ Rugged structure ensures high mobility
- ▶ IP65 front protection ( NAP series )
- ▶ 1500 cd/m<sup>2</sup> sunlight readable panel available
- ▶ Professional-use durability & around-the-clock operation
- ▶ 2-year standard warranty ( upgradable up to 5 years )

### Applications

- Broadcasting / Advertising
- Traffic control / Command center
- Directory / Ticket kiosk
- Surveillance system
- Vehicle mount display
- Bathroom TV

UltraView K43 series 43" 4K UHD LED monitor supports 3840 x 2160 resolution, 4 times the resolution of FHD. True 10-bit input enables 1.07 billion colors to be presented, achieving ultimate picture quality. Improved energy efficiency and fan-less architecture provides professional-use durability and around-the-clock operation.

K43 is more than just a standalone monitor. UltraView has a variety of embedded modules including HDMI Decoder, HDMI Extender, HDMI Quad display Extender, Multi-Monitor OSD Controller, SDI Input and Portrait Mode Kit. The embedded modules give you the ability of video remote management and transmission for multiple monitors over network.

As a versatile 4K monitor, K43 is meticulously designed to meet professional and environmental demands including Sunlight readable brightness, IP54 Front protection, Multi-touch, Anti-reflective/Vandal proof glass, DC power input, Brightness dimming and Mounting kit for Overhead tilted wall-mount, Panel-mount, VESA-mount, Universal-mount and Desktop stand.

With over 22 years' production experience, the K43 structure is well-engineered and manufactured by our own CNC facilities and team of experts to ensure its ruggedness, mobility and quality, as well as being suitable for harsh environment applications. The structure can be customized if required to facilitate monitor installation. Our knowledgeable engineers are able to provide frame customization for specific dimensions, color, metal treatment, screen printing, bezel and mounting.

## Options

### Video Management & Transmission over Network

- Embedded HDMI Decoder Module 1080p over IP
- Embedded HDMI Extender Module 1080p over network
- Embedded HDMI Quad Display Module 1080p over network
- Embedded HDMI Quad Display Extension Module
- Embedded Multi Monitor OSD Control Module over serial
- Embedded 3G / HD / SD-SDI Input Module
- Embedded Portrait Mode Module
- Embedded Brightness Dimming Module

### Bezel & Frame Customization

- Dimension
- Color & Treatment
- Screen Printing
- Stainless Steel Bezel

### Touchscreen & Glass Protection

- Infrared 10-point Touch
- Anti-reflective Glass
- Vandal Proof Glass

### DC Power

- 24V / 48V / 125VDC ( 150 Watt )

### Mounting

- VESA mount, 600 x 400mm ( bundled )
- Universal mount ( bundled )
- Overhead tilted wall-mount ( option )
- Desktop stand ( option )
- Wall mount, 600 x 400mm ( bundled )

### 350 cd/m<sup>2</sup> Brightness

8mm aluminum front bezel



AP-K43

8mm aluminum front bezel   
NEMA 4 / IP65 front protection



NAP-K43

Aluminum front cover



DP-K43

Universal open frame



OP-K43

### MP-K43

Industrial Display Kit



- 4K 43" LED
- LCD controller
- AC power

### 1500 cd/m<sup>2</sup> Sunlight Readable Brightness

8mm aluminum front bezel 



HAP-K43

8mm aluminum front bezel   
NEMA 4 / IP65 front protection 



NHAP-K43

Aluminum front cover 



HDP-K43

Universal open frame 



HOP-K43

## Options — Video Management & Transmission over Network

### Embedded HDMI Decoder Module 1080p over IP

- Decodes RTSP, RTMP, UDP, HTTP, HLS protocols
- Supports video resolutions up to 1080p / 60Hz
- Unicast and multicast support
- Operates on standard 1000Mb Ethernet networks
- Built-in Web UI for configuration and control
- Excellent image quality with very low delay

**Part no.**

Embedded HDMI Decoder Module : **UV-DE100F**  
 Standalone HDMI Decoder : **UV-SDE100F**  
 Standalone HDMI Encoder : **UV-SEN100F**

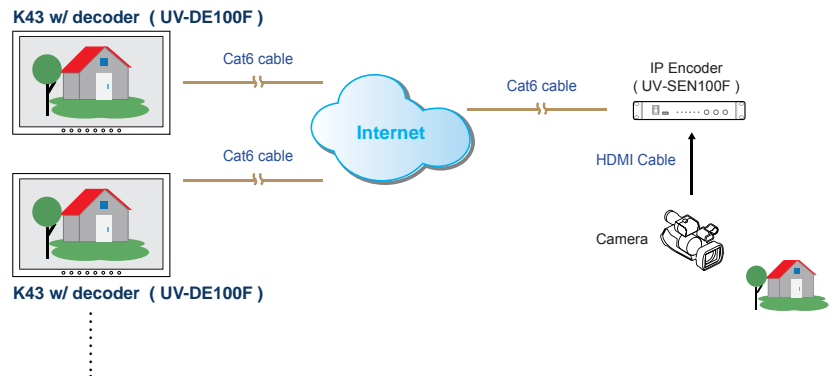

### Embedded HDMI Receiver Module 1080p

- Extends the HDMI signal over a single Cat5/6 cable
- Supports video resolutions up to 1080p / 60Hz
- One to one just via Cat5/6 cable
- One to multi via network hub and Cat5/6 cable
- 100m maximum Cat5/6 cable distance
- Supports bi-directional IR communication
- High Speed HDMI 1.3 and HDCP 1.1 compliant
- No software or drivers required

**Part no.**

Embedded HDMI Receiver Module : **UV-R100F**  
 Standalone HDMI Receiver : **UV-SR100F**  
 Standalone HDMI Transmitter : **UV-ST100F**

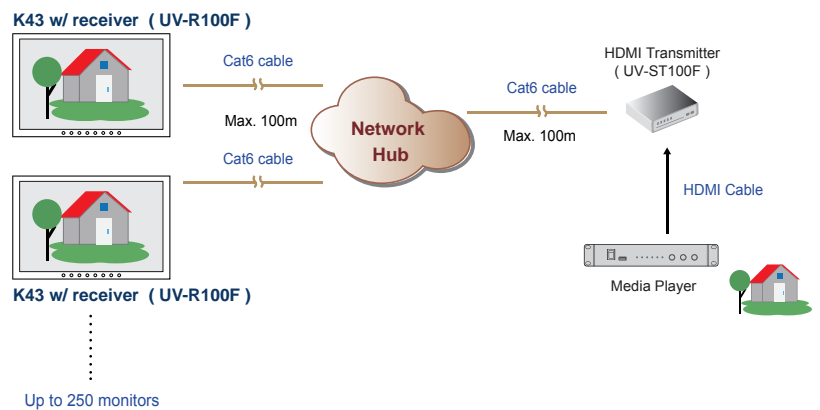

### Embedded HDMI Quad Display Module 1080p

- Allows 4 x HDMI inputs to be monitored simultaneously
- Quad split, panel left and full screen monitoring modes
- High speed HDMI 1.3a and HDCP 1.2 compliant
- Supports video resolutions up to 1080p / 60Hz
- Supports Scaler Up and Down function
- Control via local front panel and IR remote

**Part no.**

Embedded HDMI Quad Display Module : **QD-1080**  
 Embedded Quad Display Extension Module : **QD-E1080**

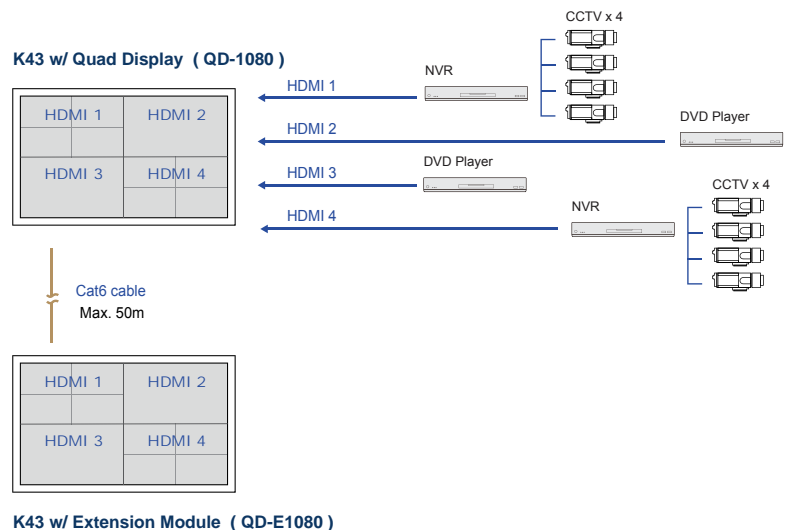

## Options — Video Management & Transmission over Network

### Embedded Multi Monitor OSD Control Module over serial

- Remote control the monitor OSD via RS-232C serial interface
- Daisy chain up to 64 monitors via Cat5/6 cable
- Individual ID for individual monitor OSD settings
- Power ON or OFF monitor
- Adjust brightness & audio
- Switch video sources

Up to 64 monitors  
Up to 1,000m distance

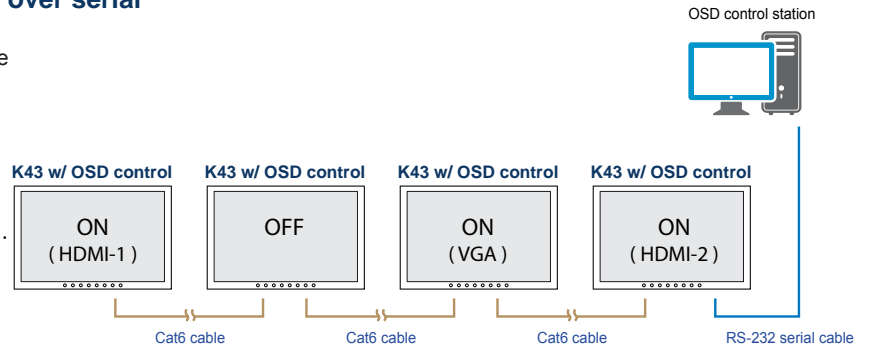

**Part no.**

Embedded Multi Monitor OSD Control Module : **MCS**

### Embedded 3G / HD / SD-SDI Input Module

- Intelligent SDI monitoring with broadcast quality scopes
- Supports multi-rate 3G / HD / SD-SDI format
- Provides input to output loop-through capability
- Auto format sensing & selection

**Part no.**

Embedded 3G / HD / SD-SDI Input Module : **SDI**

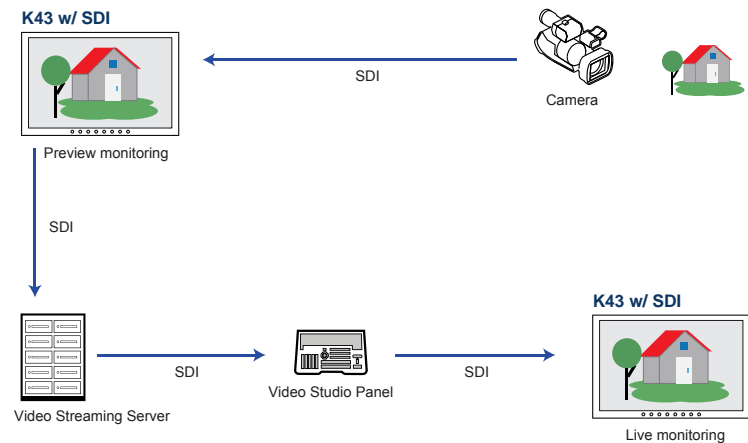

### Embedded Portrait Mode Module

- Provides users with a rotation feature ( 0, 90, 180 & 270 orientation ) without frame delay via OSD
- Allows distortion-free display of content in various orientations
- Creates new application opportunities



**K43**  
w/ Portrait mode module

**Part no.**

Embedded Portrait Mode Module : **AD4.0-P**

### Embedded Auto Brightness Dimming Module

- Brightness changes according to its ambient brightness
- Its brightness change causes 10% increase or decrease

**Part no.**

Embedded Brightness Auto Dimming Module : **DA-01**

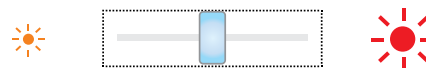

### Embedded Manual Brightness Dimming Knob

- Easy-to-use IP54 dimming knob on the front panel
- One click causes 2% brightness increase or decrease
- Brightness adjustment from 0% to 100%

**Part no.**

Brightness Dimming Knob : **DS-01**

## Option — Infrared 10-point Touch

	IR-10 Infrared
Technology	Infrared
Touch Point	10
Input Type	Pen, Finger, Finger of gloved hand activation
Touch Point Accuracy	± 2 mm
Response Speed	≤ 15 ms
Activation Force	No minimum touch activation force
Touch Durability	Unlimited
Glass Thickness	3 mm
Connector	A-type USB
Operating System	Windows 7 / Windows 10

Part no. : K43-IR10

\*\* Dimension will be changed  
if multi-touch required

## Options — DC Power

		24V	48V	125V
Input rating	Input voltage	24-Volt	48-Volt	110-Volt
	Input range	18 ~ 36V	36 ~ 75V	43 ~ 160V
Input current	No load	100 mA	50 mA	10 mA
	Full load	7386 mA	3611 mA	1540 mA
Output rating	Output voltage	24-Volt	24-Volt	24-Volt
	Output current	6.25A	6.25A	6.25A
Efficiency		88%	90%	89%

Part no. : 24VDC  
48VDC  
125VDC

## Product Specifications

LCD Panel	Standard	Sunlight Readable
Brightness (cd/m <sup>2</sup> )	350	1500 
Contrast ratio (typ.)	1000 : 1	1100 : 1
MTBF (hrs)	30,000	50,000
Panel size (diagonal)	43-inch widescreen TFT color LCD	
Native resolution	3840 x 2160	
Colors	1.07 Billion, 10-bit	
Viewing angle (L/R/U/D)	89/89/89/89	
Response time (ms)	12	
Dot pitch (mm)	0.2451	
Display area (mm)	941.184H x 529.416V	
Surface treatment	Anti-glare	
Surface hardness	2H	
Backlight type	LED	

Design	AP-K43	NAP-K43	DP-K43	OP-K43
Protection	6mm front bezel	NEMA 4 / IP65	front cover	open frame
Front panel	Black, RAL 9005			-
Rear casing	Black, RAL 9005			

Mounting	AP-K43 / NAP-K43	DP-K43	OP-K43
VESA mount	600 x 400 mm	600 x 400 mm	600 x 400 mm
Universal mount	-	-	bundled
Overhead tilted wall-mount	option	option	-
Desktop stand	option	option	-
Wall mount	600 x 400 mm	600 x 400 mm	-

Video	
Digital :	
Display port	DP 1.2 / HDCP 1.3
HDMI	HDMI 2.0 / HDCP 2.2 HDMI 1.4 / HDCP 1.4

Physical	AP-K43 / NAP-K43	DP-K43	OP-K43	
Product (W x D x H) :	mm	1025 x 82.8 x 619	999 x 76.8 x 593	1022 x 74.8 x 616
	inch	40.4 x 3.3 x 24.4	39.3 x 3 x 23.3	40.2 x 2.9 x 24.3
Packing (W x D x H) :	mm	1122 x 199 x 712	1122 x 199 x 712	1122 x 199 x 712
	inch	44.2 x 7.8 x 28	44.2 x 7.8 x 28	44.2 x 7.8 x 28
Net weight	31.7 kg / 69.7 lb	35.7 kg / 78.5 lb	29 kg / 63.8 lb	26.2 kg / 57.6 lb
Gross weight	37.5 kg / 82.5 lb	41.5 kg / 91.3 lb	34.8 kg / 76.6 lb	32 kg / 70.4 lb
Chassis color	dark			
Chassis materials	Aluminum			

Audio	
Audio output :	
Connector	3.5mm stereo jack
Resistance / Power level	30kΩ / 2.8V
Speaker :	
Dual stereo speaker	10W x 2

Compliance	
EMC	FCC & CE certified
Safety	CE / LVD certified
Environment	RoHS2 & REACH compliant

\*When the audio output is connected, speaker output is OFF

Power		
Input	Auto-sensing 100 to 240VAC, 50 / 60Hz	
Consumption :		
Screen on	Max. 68W	Max. 220W
Power saving mode	Max. 9W	Max. 9W
Power button on	Max. 2W	Max. 2W

Applicable Format		
Display port input	PC signal	3840 x 2160 x 60Hz 1920 x 1080 x 60Hz 1600 x 1200 x 60Hz 1360 x 768 x 60Hz 1280 x 1024 x 60 / 75Hz 1280 x 768 x 60Hz 1024 x 768 x 60 / 70 / 75Hz 800 x 600 x 60 / 72 / 75Hz 720 x 400 x 70Hz 640 x 480 x 60 / 72 / 75Hz
	Audio signal	2ch Linear PCM
HDMI input	HDMI 2.0	3840 x 2160 x 60 Hz
	HDMI 2.0 / 1.4	3840 x 2160 x 30 Hz 1920 x 1080 x 50 / 60Hz ( 1080p ) 1920 x 1080 x 25 / 30Hz ( 1080i ) 1280 x 720 x 50 / 60Hz ( 720p ) 720 x 480 x 50 / 60Hz ( 576p / 480p )
		Audio signal

Environment	
Operating temp.	0 to 55°C degree
Storage temp.	-20 to 60°C degree
Operating humidity	20~90%, non-condensing
Storage humidity	5 ~90%, non-condensing
Operating altitude	16,000 ft
Non-operating altitude	40,000 ft
Shock	10G acceleration ( 11ms duration )
Vibration	10~300Hz 0.5G RMS random vibration

### Diagrams ( mm )

Front View

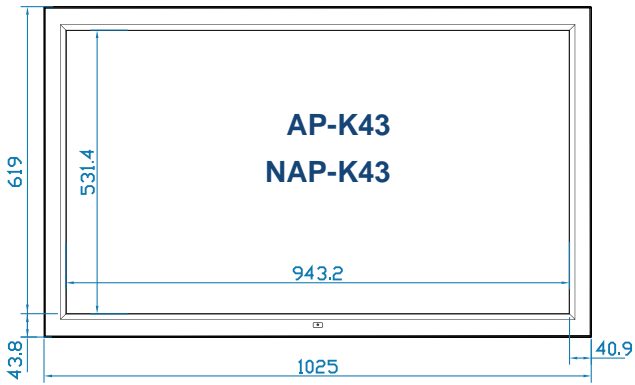

Side View

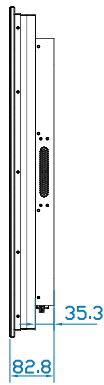

Rear View

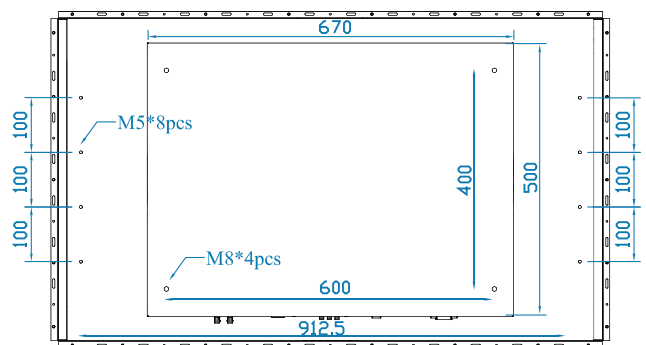
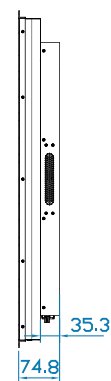
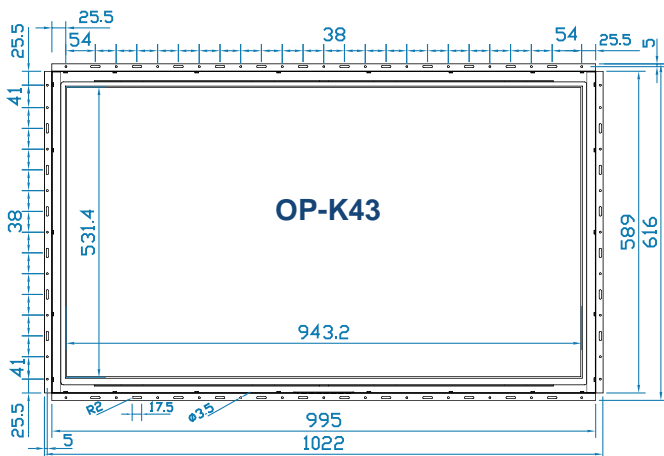
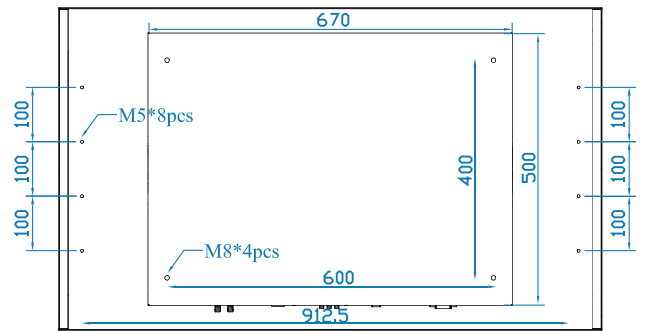
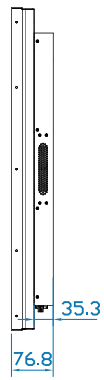
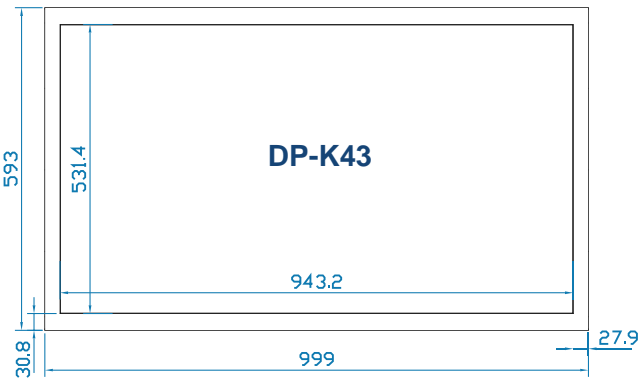
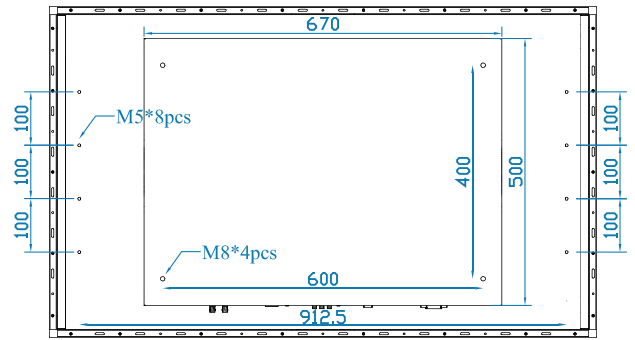

## UltraView Family

UltraView series covers a full range of professional LCD display sizes from 6.5" to 65". Please select from the below the most suitable model for your application.

### Sales Inquiry

[inquiry@austin-hughes.com](mailto:inquiry@austin-hughes.com)

### Technical Support

[support@austin-hughes.com](mailto:support@austin-hughes.com)

### 16 : 9 ( 4K / 1080p )

- K65"
- K55"
- K43"
- K32"
- K28"
- K23"
- K17"
- K15"

### 16 : 9 ( 1080p )

- F21"
- F17"
- F15"

### 16 : 10

- X24" ( 1920 x 1200 )
- X17" ( 1920 x 1200 )
- W19" ( 1440 x 900 )

### 4 : 3

- 20" ( 1600 x 1200 )
- 19" ( 1280 x 1024 )
- 17" ( 1280 x 1024 )
- 15" ( 1024 x 768 )
- 12" ( 800 x 600 )
- 10" ( 800 x 600 )
- 8" ( 800 x 600 )
- 6" ( 640 x 480 )

## Sunlight Readable

### 16 : 9 ( 4K / 1080p )

- K65"
- K55"
- K43"
- K32"

### 16 : 9 ( 1080p )

- F21"
- F17"

### 16 : 10

- W19" ( 1440 x 900 )

### 4 : 3

- 19" ( 1280 x 1024 )
- 17" ( 1280 x 1024 )

**Austin Hughes** has an extensive distribution network, including EMEA, the Americas & APAC.

Contact your nearest sales office for details of local presentation.

### Sales Inquiry

[inquiry@austin-hughes.com](mailto:inquiry@austin-hughes.com)

### Technical Support

[support@austin-hughes.com](mailto:support@austin-hughes.com)

Distributed by:

Distributor by country on application