



### Key Benefits

- ▶ 16.2" LED, 1920 x 1200 **WUXGA** native resolution
- ▶ 16.7 M colors ( 8-bit ) / 300 cd/m<sup>2</sup> brightness
- ▶ PIP Sub-screen & PBP Dual-screen viewing efficiency
- ▶ HDMI 1.3 + DVI-D + S-Video + BNC + VGA video input
- ▶ Rugged structure ensures high mobility
- ▶ IP65 front protection ( NAP series )
- ▶ Professional-use durability & around-the-clock operation
- ▶ 2-year standard warranty ( upgradable up to 5 years )

### Applications

- Broadcasting / Advertising
- Traffic control / Command center
- Directory / Ticket kiosk
- Surveillance system
- Vehicle mount display
- Bathroom TV

UltraView X17 series 16.2" WUXGA LED monitor supports 1920 x 1200 resolution. 16.7 million colors achieve optimal picture quality. Improved energy efficiency and fan-less architecture provides professional-use durability and around-the-clock operation.

X17 is more than just a standalone monitor. UltraView has a variety of embedded modules including Multi-Monitor OSD Controller and SDI Input. The embedded modules give you the ability of video remote management and transmission for multiple monitors over network.

As a versatile 1920 x 1200 monitor, X17 is meticulously designed to meet professional and environmental demands including IP54 Front protection, Multi-touch, Anti-reflective/Vandal proof glass, DC power input, Brightness dimming and Mounting kit for Panel-mount, VESA-mount, Universal-mount and Desktop stand.

With over 22 years' production experience, the X17 structure is well-engineered and manufactured by our own CNC facilities and team of experts to ensure its ruggedness, mobility and quality, as well as being suitable for harsh environment applications. The structure can be customized if required to facilitate monitor installation. Our knowledgeable engineers are able to provide frame customization for specific dimensions, color, metal treatment, screen printing, bezel and mounting.

## Options

### Video Management & Transmission over Network

- Embedded Multi Monitor OSD Control Module over serial
- Embedded 3G / HD / SD-SDI Input Module
- Embedded Brightness Dimming Module

### Bezel & Frame Customization

- Dimension
- Color & Treatment
- Screen Printing
- Stainless Steel Bezel

### Touchscreen & Glass Protection

- 5-Wire Resistive 1-point Touch
- Capacitive 1-point Touch
- Anti-reflective Glass
- Vandal Proof Glass

### DC Power

- 12V / 24V / 48V / 125VDC ( 50 Watt )

### Mounting

- VESA mount, 100 x 100mm ( bundled )
- Universal mount ( bundled )
- Desktop stand ( option )
- Panel mount ( bundled )

6mm aluminum front bezel

6mm aluminum front bezel  
NEMA 4 / IP65 front protection



AP-X17



NAP-X17

Aluminum front cover

Universal open frame



DP-X17



OP-X17

### Diagrams ( mm )

Front View

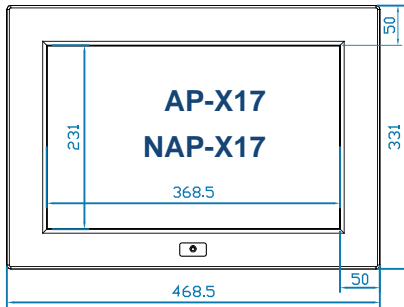

Side View

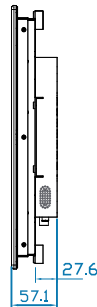

Rear View

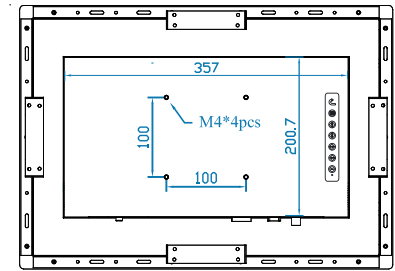

Front View

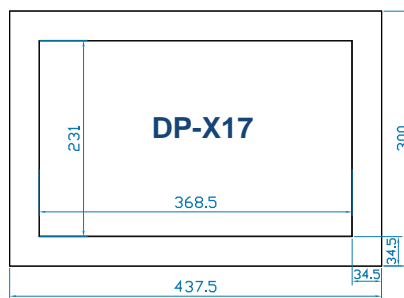

Side View

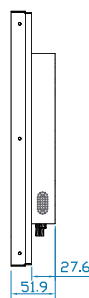

Rear View

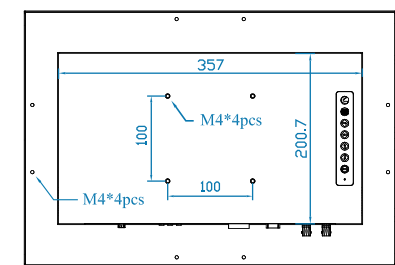

Front View

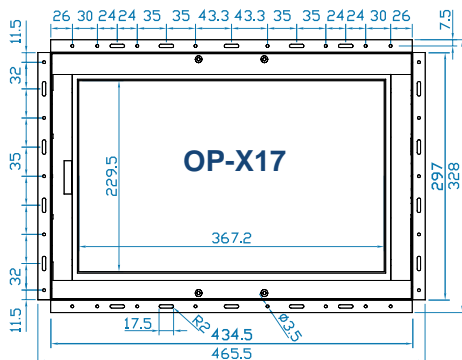

Side View

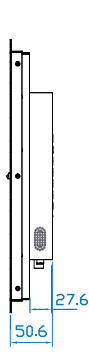

Rear View

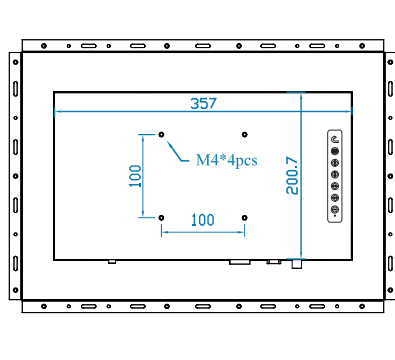

## Options — Video Management & Transmission over Network

### Embedded Multi Monitor OSD Control Module over serial

- Remote control the monitor OSD via RS-232C serial interface
- Daisy chain up to 64 monitors via Cat5/6 cable
- Individual ID for individual monitor OSD settings
- Power ON or OFF monitor
- Adjust brightness & audio
- Switch video sources

Up to 64 monitors  
Up to 1,000m distance

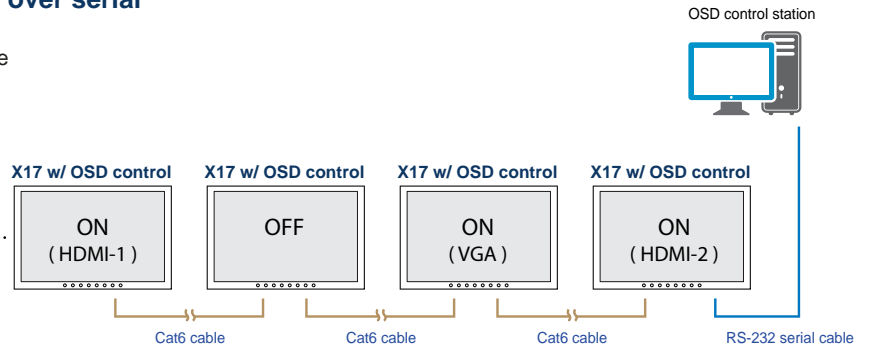

**Part no.**

Embedded Multi Monitor OSD Control Module : **MCS**

### Embedded 3G / HD / SD-SDI Input Module

- Intelligent SDI monitoring with broadcast quality scopes
- Supports multi-rate 3G / HD / SD-SDI format
- Provides input to output loop-through capability
- Auto format sensing & selection

**Part no.**

Embedded 3G / HD / SD-SDI Input Module : **SDI**

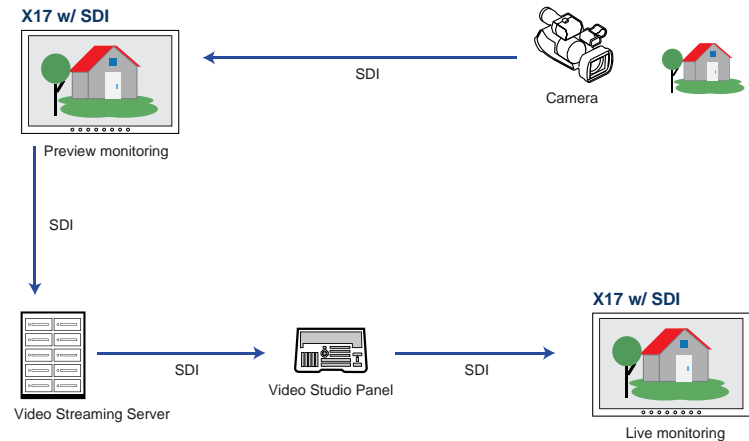

### Embedded Auto Brightness Dimming Module

- Brightness changes according to its ambient brightness
- Its brightness change causes 10% increase or decrease

**Part no.**

Embedded Brightness Auto Dimming Module : **DA-01**

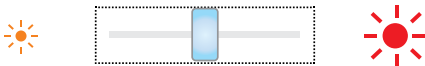

### Embedded Manual Brightness Dimming Knob

- Easy-to-use IP54 dimming knob on the front panel
- One click causes 2% brightness increase or decrease
- Brightness adjustment from 0% to 100%

**Part no.**

Brightness Dimming Knob : **DS-01**

## Option — e-Resistive 1-point Touch

	TRB e-Resistive
Technology	5-Wire Resistive
Touch Point	Single
Input Type	Finger or Stylus
Resolution	2048 x 2048
Response Speed	15 ms
Activation Force	≤ 50 g
Surface Hardness	3H
Light Transmission	80% ± 3%
Haze	8% ± 3%
Durability	10 million touches
Top Layer	ITO Film
Bottom Layer	ITO Glass
Thickness	2.2 ± 0.2 mm
Connector	USB Type A
Compatibility	Windows 7 / XP / Linux / Mac

Part no. : X17TRB

\*\* Dimension will be changed if multi-touch required

## Option — e-Capacitive 1-point Touch

	TCB e-Capacitive
Technology	Capacitive
Touch Point	Single
Input Type	Finger
Resolution	2048 x 2048
Response Speed	20 ms
Activation Force	≤ 50 g
Surface Hardness	9H
Light Transmission	92% ± 2%
Haze	7%
Durability	300 million touches
Top Layer	Glass
Bottom Layer	Glass
Thickness	2.8 ± 10%
Connector	USB Type A
Compatibility	Windows 7 / XP / Linux / Mac

Part no. : X17TCB

\*\* Dimension will be changed if multi-touch required

## Options — DC Power

		12V	24V	48V	125V
Input rating	Input voltage	12-Volt	24-Volt	48-Volt	110-Volt
	Input range	9 ~ 18V	18 ~ 36V	36 ~ 75V	66 ~ 160V
Input current	No load	50 mA	50 mA	50 mA	35 mA
	Full load	4950 mA	2450 mA	1220 mA	749 mA
Output rating	Output voltage	12-Volt	12-Volt	12-Volt	12-Volt
	Output current	4.16A	4.16A	4.16A	6.25A
Efficiency		84%	85%	85%	91%

Part no. : 12VDC  
24VDC  
48VDC  
125VDC

## Product Specifications

LCD Panel	
Panel size (diagonal)	16.2-inch widescreen TFT color LCD
Native resolution	1920 x 1200
Brightness (cd/m <sup>2</sup> )	300
Contrast ratio (typ.)	800 : 1
Colors	16.7 M, 8-bit
Viewing angle (L/R/U/D)	89/89/89/89
Response time (ms)	30
Dot pitch (mm)	0.191
Display area (mm)	343.8H x 214.9V
Surface treatment	Anti-glare, Hard-coating
Surface hardness	3H
Backlight type	LED
MTBF (hrs)	20,000

Design	AP-X17	NAP-X17	DP-X17	OP-X17
Protection	6mm front bezel	NEMA 4 / IP65	front cover	open frame
Front panel	Black, RAL 9005			-
Rear casing	Black, RAL 9005			

Mounting	AP-X17 / NAP-X17	DP-X17	OP-X17
VESA mount	100 x 100 mm	100 x 100 mm	100 x 100 mm
Universal mount	-	-	bundled
Desktop stand	option	option	-
Panel mount	bundled	-	-

Video	
Digital :	
DVI	DVI-D single link
HDMI	HDMI 1.3 / HDCP 1.3
Analog :	
VGA	Analog 0.7Vp-p
Composite ( BNC )	NTSC & PAL
S-Video ( 4-pin )	NTSC & PAL

Physical	AP-X17 / NAP-X17	DP-X17	OP-X17
Product (W x D x H) :			
mm	468.5 x 57.1 x 331	437.5 x 51.9 x 300	465.5 x 50.6 x 328
inch	18.4 x 2.2 x 13	17.2 x 2 x 11.8	18.3 x 2 x 12.9
Packing (W x D x H) :			
mm	615 x 113 x 523	615 x 113 x 523	615 x 113 x 523
inch	24.2 x 4.4 x 20.6	24.2 x 4.4 x 20.6	24.2 x 4.4 x 20.6
Net weight	4.9 kg / 10.8 lb	4.9 kg / 10.8 lb	4.4 kg / 9.7 lb
Gross weight	7.7 kg / 16.9 lb	7.7 kg / 16.9 lb	7.1 kg / 15.6 lb
Chassis color	dark		
Chassis materials	Aluminum		

Audio	
Audio input :	
Connector	3.5mm stereo jack
Impedance / Power level	30kΩ / 750mV
Audio output :	
Connector	3.5mm stereo jack
Resistance / Power level	30kΩ / 2.8V
Speaker :	
Dual stereo speaker	2W x 2

Compliance	
EMC	FCC & CE certified
Safety	CE / LVD certified
Environment	RoHS2 & REACH compliant

\*When the audio output is connected, speaker output is OFF

Power	
Input	Auto-sensing 100 to 240VAC, 50 / 60Hz
Consumption :	
Screen on	Max. 34W
Power saving mode	Max. 4W
Power button on	Max. 1W

Applicable Format		
Display port input	PC signal	1920 x 1200 x 60Hz 1360 x 768 x 60Hz 1280 x 1024 x 60 / 75Hz 1280 x 960 x 60Hz 1280 x 768 x 60 / 75Hz 1152 x 864 x 75Hz 1024 x 768 x 60 / 70 / 75Hz 848 x 480 x 60Hz 800 x 600 x 60 / 72 / 75Hz 720 x 400 x 70Hz 640 x 480 x 60 / 72 / 75Hz 640 x 400 x 70Hz 640 x 350 x 70Hz
	Audio signal	2ch Linear PCM
HDMI input	PC signal	Same as VGA
	HDMI 1.3	1920 x 1080 x 50 / 60Hz ( 1080p ) 1920 x 1080 x 25 / 30Hz ( 1080i ) 1280 x 720 x 50 / 60Hz ( 720p ) 720 x 480 x 50 / 60Hz ( 576p / 480p )
	Audio signal	2ch Linear PCM

Environment	
Operating temp.	0 to 55°C degree
Storage temp.	-20 to 60°C degree
Operating humidity	20-90%, non-condensing
Storage humidity	5 -90%, non-condensing
Operating altitude	16,000 ft
Non-operating altitude	40,000 ft
Shock	10G acceleration ( 11ms duration )
Vibration	10-300Hz 0.5G RMS random vibration

## UltraView Family

UltraView series covers a full range of professional LCD display sizes from 6.5" to 65". Please select from the below the most suitable model for your application.

### Sales Inquiry

[inquiry@austin-hughes.com](mailto:inquiry@austin-hughes.com)

### Technical Support

[support@austin-hughes.com](mailto:support@austin-hughes.com)

### 16 : 9 ( 4K / 1080p )

- K65"
- K55"
- K43"
- K32"
- K28"
- K23"
- K17"
- K15"

### 16 : 9 ( 1080p )

- F21"
- F17"
- F15"

### 16 : 10

- X24" ( 1920 x 1200 )
- X17" ( 1920 x 1200 )
- W19" ( 1440 x 900 )

### 4 : 3

- 20" ( 1600 x 1200 )
- 19" ( 1280 x 1024 )
- 17" ( 1280 x 1024 )
- 15" ( 1024 x 768 )
- 12" ( 800 x 600 )
- 10" ( 800 x 600 )
- 8" ( 800 x 600 )
- 6" ( 640 x 480 )

## Sunlight Readable

### 16 : 9 ( 4K / 1080p )

- K65"
- K55"
- K43"
- K32"

### 16 : 9 ( 1080p )

- F21"
- F17"

### 16 : 10

- W19" ( 1440 x 900 )

### 4 : 3

- 19" ( 1280 x 1024 )
- 17" ( 1280 x 1024 )

**Austin Hughes** has an extensive distribution network, including EMEA, the Americas & APAC.

Contact your nearest sales office for details of local presentation.

### Sales Inquiry

[inquiry@austin-hughes.com](mailto:inquiry@austin-hughes.com)

### Technical Support

[support@austin-hughes.com](mailto:support@austin-hughes.com)

Distributed by:

Distributor by country on application