

## User Manual

PPS-01, IP dongle GUI software

MTS switched PDU

MT monitored PDU



Designed and manufactured by Austin Hughes

## Legal Information

First English printing, October 2002

Information in this document has been carefully checked for accuracy; however, no guarantee is given to the correctness of the contents. The information in this document is subject to change without notice. We are not liable for any injury or loss that results from the use of this equipment.

## Safety Instructions

**Please read all of these instructions carefully before you use the device. Save this manual for future reference.**

- Unplug equipment before cleaning. Don't use liquid or spray detergent; use a moist cloth.
- Keep equipment away from excessive humidity and heat. Preferably, keep it in an air-conditioned environment with temperatures not exceeding 40° Celsius (104° Fahrenheit).
- When installing, place the equipment on a sturdy, level surface to prevent it from accidentally falling and causing damage to other equipment or injury to persons nearby.
- When the equipment is in an open position, do not cover, block or in any way obstruct the gap between it and the power supply. Proper air convection is necessary to keep it from overheating.
- Arrange the equipment's power cord in such a way that others won't trip or fall over it.
- If you are using a power cord that didn't ship with the equipment, ensure that it is rated for the voltage and current labeled on the equipment's electrical ratings label. The voltage rating on the cord should be higher than the one listed on the equipment's ratings label.
- Observe all precautions and warnings attached to the equipment.
- If you don't intend on using the equipment for a long time, disconnect it from the power outlet to prevent being damaged by transient over-voltage.
- Keep all liquids away from the equipment to minimize the risk of accidental spillage. Liquid spilled on to the power supply or on other hardware may cause damage, fire or electrical shock.
- Only qualified service personnel should open the chassis. Opening it yourself could damage the equipment and invalidate its warranty.
- If any part of the equipment becomes damaged or stops functioning, have it checked by qualified service personnel.

## What the warranty does not cover

- Any product, on which the serial number has been defaced, modified or removed.
- Damage, deterioration or malfunction resulting from:
  - Accident, misuse, neglect, fire, water, lightning, or other acts of nature, unauthorized product modification, or failure to follow instructions supplied with the product.
  - Repair or attempted repair by anyone not authorized by us.
  - Any damage of the product due to shipment.
  - Removal or installation of the product.
  - Causes external to the product, such as electric power fluctuation or failure.
  - Use of supplies or parts not meeting our specifications.
  - Normal wear and tear.
  - Any other causes which does not relate to a product defect.
- Removal, installation, and set-up service charges.

## Regulatory Notices Federal Communications Commission (FCC)

This equipment has been tested and found to comply with the limits for a Class B digital device, pursuant to Part 15 of the FCC rules. These limits are designed to provide reasonable protection against harmful interference in a residential installation.

Any changes or modifications made to this equipment may void the user's authority to operate this equipment. This equipment generates, uses, and can radiate radio frequency energy and, if not installed and used in accordance with the instructions, may cause harmful interference to radio communications.

However, there is no guarantee that interference will not occur in a particular installation. If this equipment does cause harmful interference to radio or television reception, which can be determined by turning the equipment off and on, the user is encouraged to try to correct the interference by one or more of the following measures:

- Re-position or relocate the receiving antenna.
- Increase the separation between the equipment and receiver.
- Connect the equipment into an outlet on a circuit different from that to which the receiver is connected.

The company reserves the right to modify product specifications without prior notice and assumes no responsibility for any error which may appear in this publication.

All brand names, logo and registered trademarks are properties of their respective owners.

Copyright 2011 Austin Hughes Electronics Ltd. All rights reserved.

# Unpacking

The equipment comes with the standard parts shown on the package contents. Check and make sure they are included and in good condition. If anything is missing, or damage, contact the supplier immediately.

## Package contents

### ( 1 ) Vertical MTS / MT PDU x 1

- VMS mounting screw, set of 2 or 3



- VMB mounting bracket set

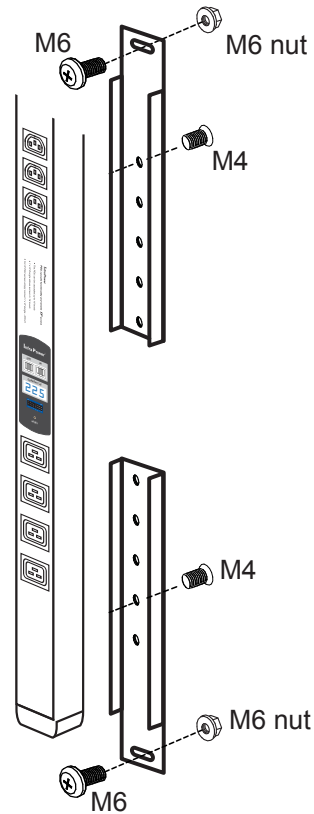
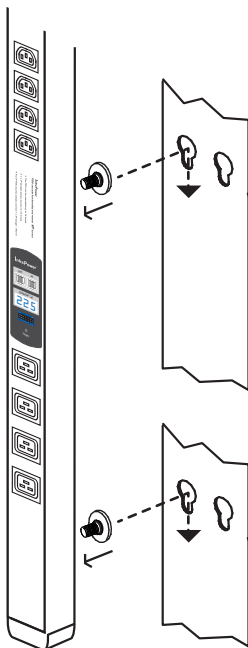
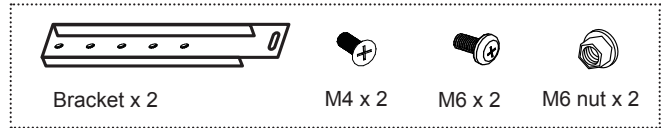

OR

### ( 2 ) Rackmount MTS / MT PDU x 1

## Power ON

- Connect the PDU into an appropriately rated receptacle
- When the PDU is power on, the LED display will light up. That means all outlets are activated
- Keep the equipments in the power off position until it is plugged into the PDU

 Don't exceed the outlet, branch or phase limitations

# Content

<b>&lt; 1.1 &gt; PDU meter setting &amp; cascade</b>	<b>P. 1 - 2</b>
<b>&lt; 1.2 &gt; IP dongle installation &amp; connection</b>	<b>P. 3 - 4</b>
<b>&lt; 1.3 &gt; IP dongle configuration</b>	<b>P. 5</b>
<b>&lt; 1.4 &gt; PPS-01 IP dongle GUI Software</b>	<b>P. 6 - 7</b>

## < 1.1 > PDU meter setting & cascade

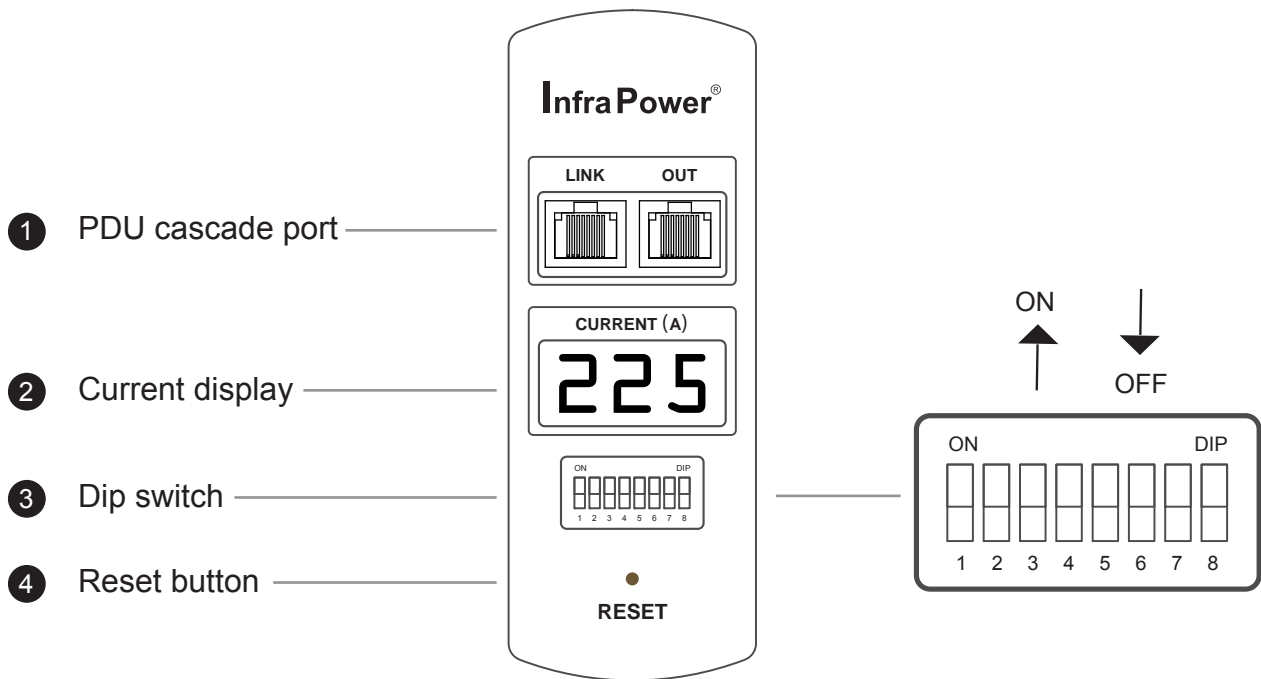

■ For rackmount PDU, ② ③ ④ on the front panel left, ① on the rear panel

### Cascaded PDUs setting

Using the **dip switch no. 1, 2, 3, 4 & 8** to setup each PDU level as below :

Cascaded PDUs	Dip switch no.				
	1	2	3	4	8
1st PDU	On	On	On	On	Off
2nd PDU	Off	On	On	On	Off
3rd PDU	On	Off	On	On	Off
4th PDU	Off	Off	On	On	Off
5th PDU	On	On	Off	On	Off
6th PDU	Off	On	Off	On	Off
7th PDU	On	Off	Off	On	Off
8th PDU	Off	Off	Off	On	Off
9th PDU	On	On	On	Off	Off
10th PDU	Off	On	On	Off	Off
11th PDU	On	Off	On	Off	Off
12th PDU	Off	Off	On	Off	Off
13th PDU	On	On	Off	Off	Off
14th PDU	Off	On	Off	Off	Off
15th PDU	On	Off	Off	Off	Off
16th PDU	Off	Off	Off	Off	Off

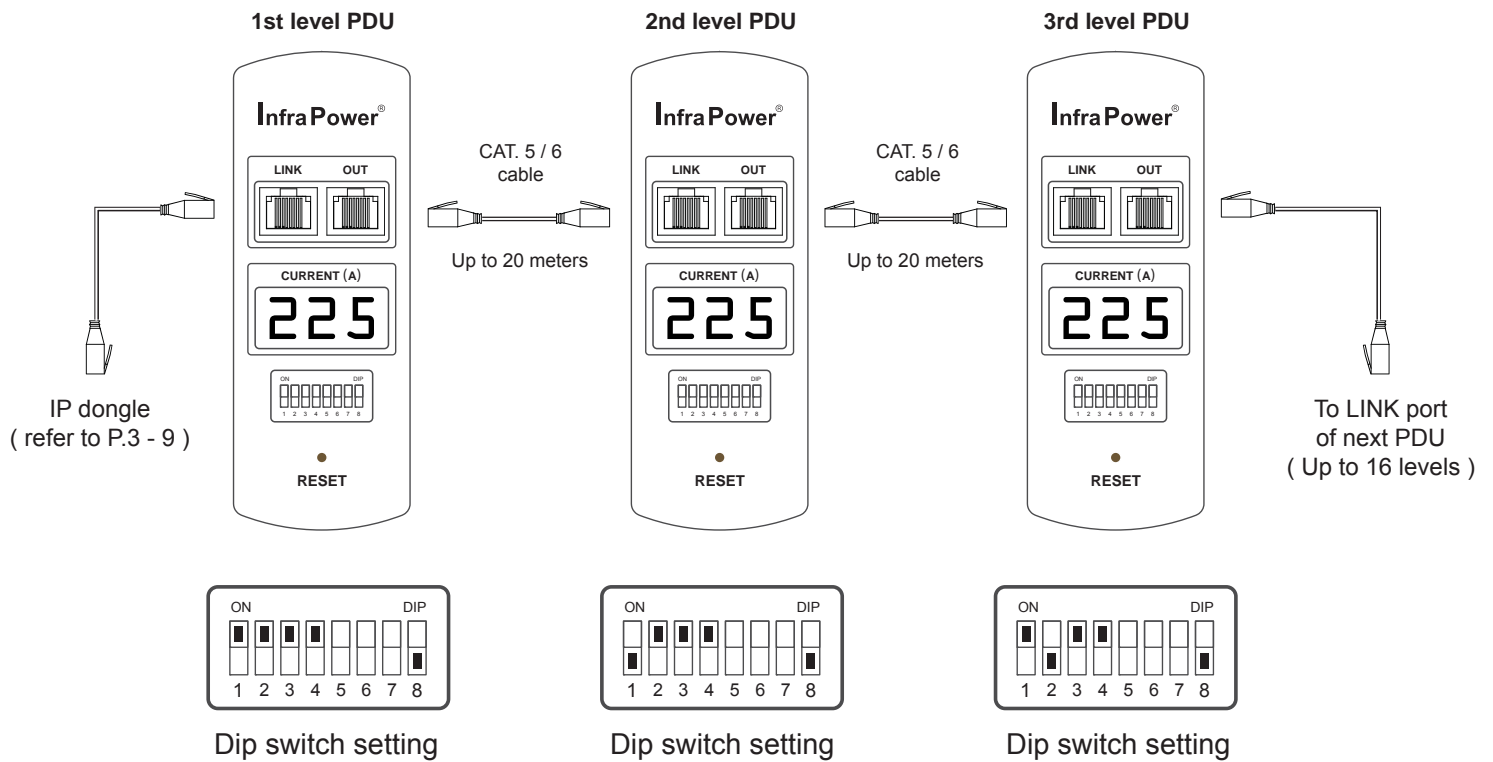

- The PDU can be cascaded up to 16 levels
- For IP PDU access simply connect 1 x IP dongle - IPD-01
- 1 x IP dongle allows access to 16 levels

## Meter display setting

Using the **dip switch no. 5 & 7** to setup each PDU meter display as below :

Current display	Dip switch no.	
	5	7
Circuit A + Circuit B	Off	Off
Circuit A only	On	Off
Circuit B only	On	On

## Audio alarm

Using the **dip switch no. 6** to setup each PDU audio alarm as below :

	Dip switch 6
Enable	Off
Disable	On

## < 1.2 > IP dongle installation & connection

To remote PDU over IP, users can order IP dongle :

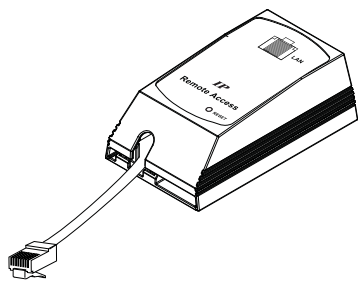

IPD-01 IP dongle for vertical PDU

Vertical IP dongle installation steps :

- slide the IP dongle on the plate above the meter
- plug the RJ-45 connector of IP dongle into the LINK port of the 1st level PDU meter
- use the CAT. 5 / 6 cable to connect IP dongle to network device



To LAN port

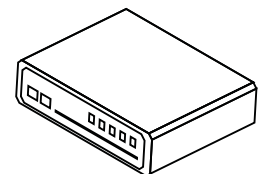
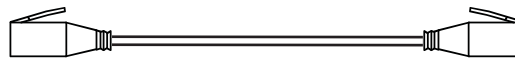

Customer's network device  
( router or hub )

IP dongle

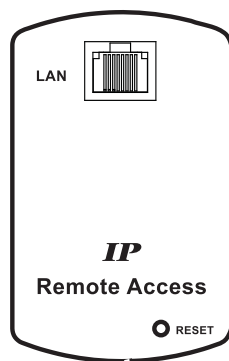

■ Please refer dip switch setting on P.1 - 2 for different level PDUs

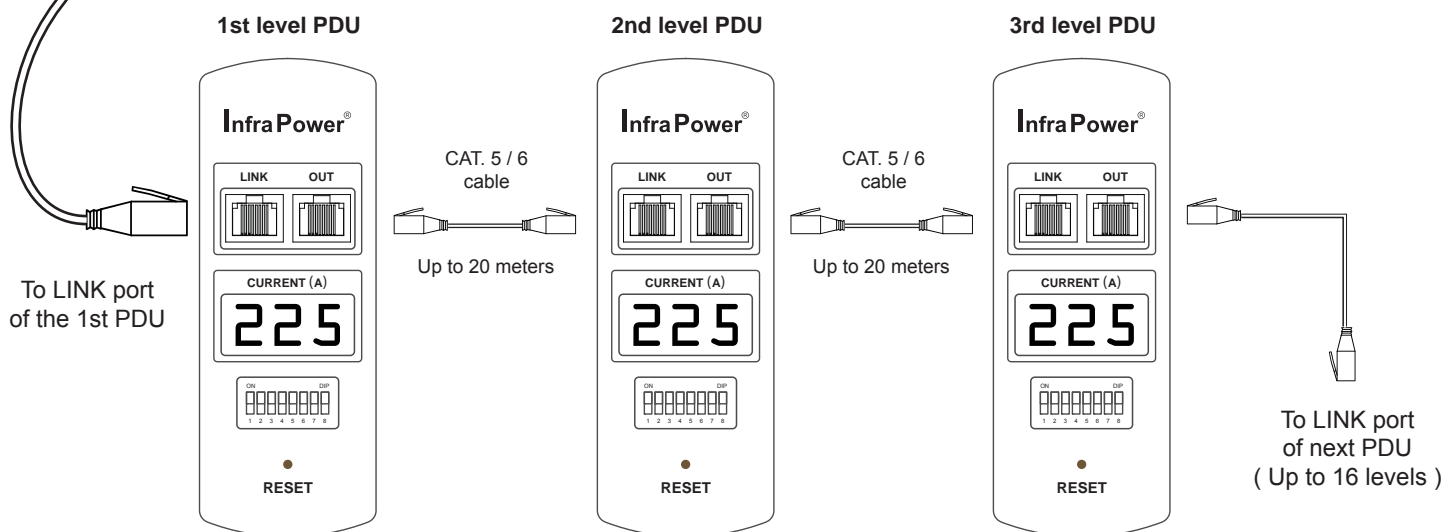

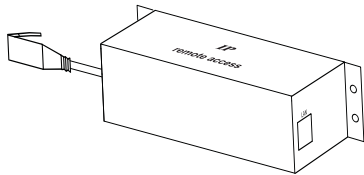

**IPD-H01 IP dongle for rackmount PDU**

**Horizontal IP dongle installation steps :**

- fix the IP dongle on the rear side of rackmount PDU with 4 screws
- plug the RJ-45 connector of IP dongle into the LINK port of the 1st level PDU meter
- use the CAT. 5 / 6 cable to connect IP dongle to network device

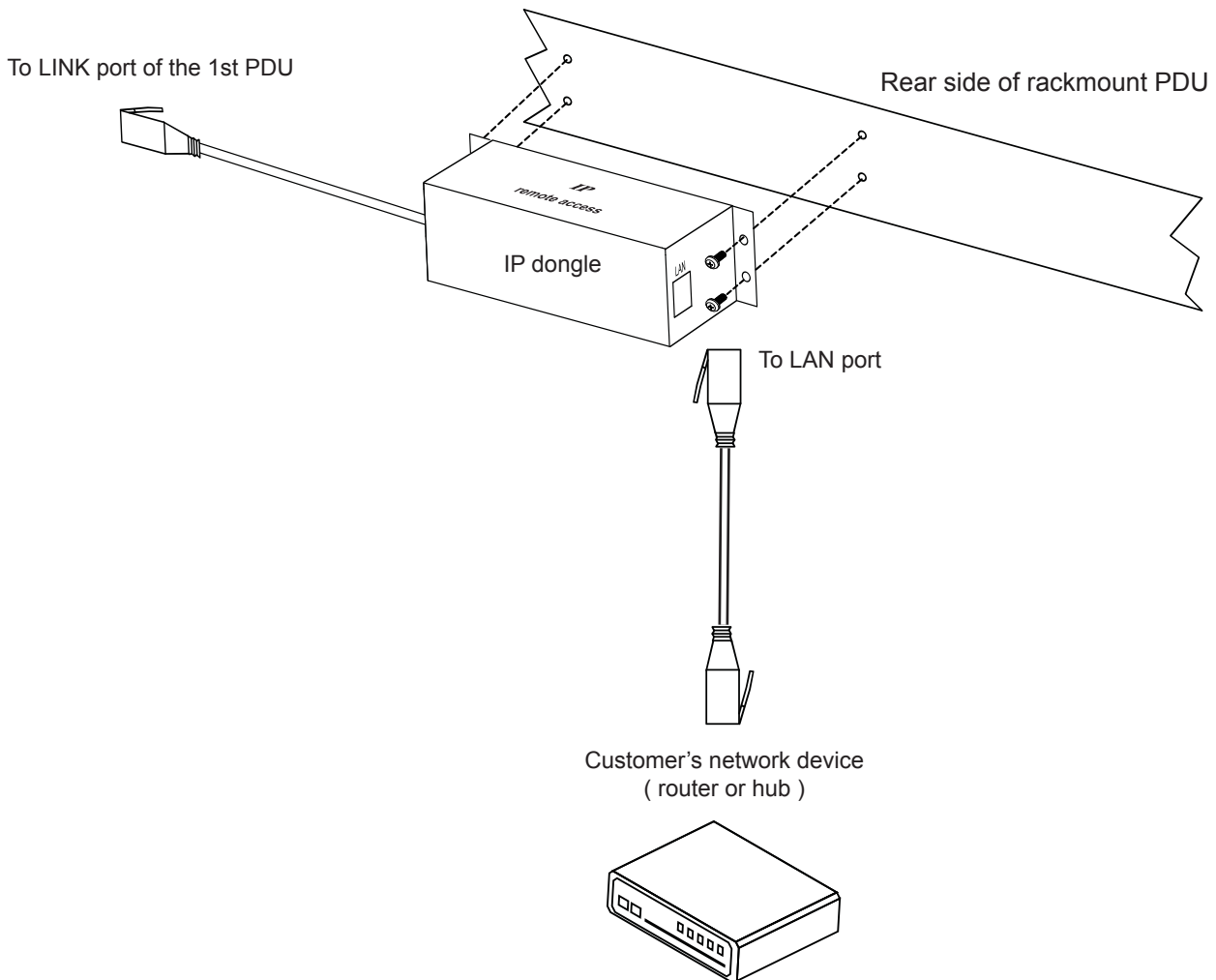

## < 1.3 > IP dongle configuration

After the completion of IP dongle connection, please take the following steps to configure the IP dongle :

1. Prepare a notebook computer to download the IP setup utilities from the link : [www.austin-hughes.com/support/utilities/infrapower/IPdongleSetup.msi](http://www.austin-hughes.com/support/utilities/infrapower/IPdongleSetup.msi)
2. Double click the IPDongleSetup.msi and follow the instruction to complete the installation.
3. Go to each first level PDU with the notebook computer & a piece of CAT. 5 / 6 cable to configure the IP dongle by IP setup utilities as below. Please take the procedure for all IP dongles **ONE BY ONE**.

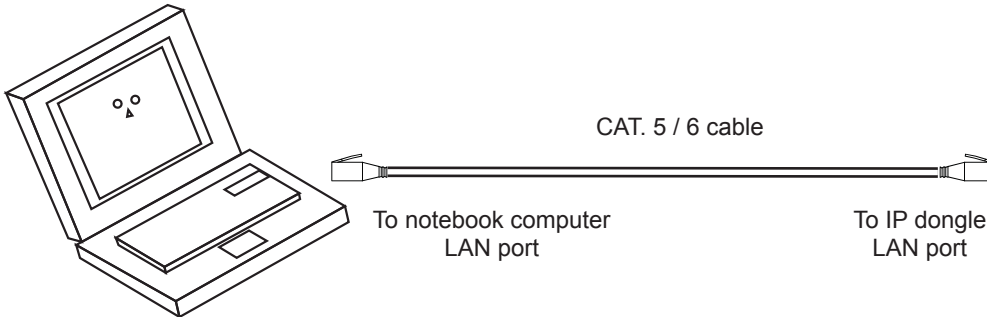

Reconnect the IP dongle with the network device ( router or hub ), after finish IP dongle configuration.

IP dongle on 1st level PDU



Ensure the PDU in power ON status

The screenshot shows the 'IP setup utilities for IP Dongle (Ver. Q411)' application. The window title is 'IP setup utilities for IP Dongle (Ver. Q411)'. The main title is 'InfraPower® Intelligent Remote Power Management'. The window is divided into two panes: 'IP Dongle list' and 'Configuration'. The 'IP Dongle list' pane shows a 'Device MAC address' field with the value '00:0D:5D:04:C8:24' and a 'Scan' button. The 'Configuration' pane has several fields: 'Name' (with a placeholder 'Name'), 'Location' (with 'Rack\_001'), 'Password', 'New password', 'Confirm new password', 'IP address' (with '192.168.0.1'), 'Subnet mask' (with '255.255.255.0'), and 'Gateway' (with '192.168.0.254'). There are 'Save' and 'Close' buttons at the bottom of the configuration pane.

4. Click **Scan** to search the connected IP dongles
5. Enter the device name ( min. 4 char. / max. 16 char. ) in the device name field. **The default is Name.**
6. Enter the location in the location field ( min. 4 char. / max. 16 char. ). **The default is Rack\_001.**
7. Enter the password for security in the password field ( min. 8 char. / max. 16 char. ). **The default is 00000000.**
8. Re-enter the new password in the Confirm new password field.
9. Change the desired IP address / Subnet mask / Gateway, then click **Save** to confirm the setting to IP dongle.
10. The default IP address is as below:  
IP address : 192.168.0.1  
Subnet mask : 255.255.255.0  
Gateway : 192.168.0.254

## < 1.4 > PPS-01 IP dongle GUI Software

Each IP dongle provides a built-in GUI software, PPS-01, which allows user, via an I.E. web browser, to see PDU's data and remotely manage the PDU over a TCP/IP Ethernet network.

 Each I.E. supports ONLY one IP dongle. If the user installs more IP dongles, multi windows will be required.

 PPS-01 is a management software but with very limited features. The user can use advanced software, InfraPower Manager IPM-01.

**Login**

IP Dongle Device: IP\_PDU

Password:

**Step 1.** Open Internet Explorer ( I.E. ), version 6.0 or above

**Step 2.** Enter the configured IP dongle address into the I.E. address bar  
( Refer to set up IP utilities p.5 )

**Step 3.** Enter password ( Refer to set up IP utilities P.5 )

### < Status >

- Status of all connected PDUs
- Aggregate current on each PDU
- Latest loading on each circuit of PDU
- Alarm threshold setup

- Data refresh every 10 seconds

- Disable **Refresh** during data input

IP Dongle Device : IP_PDU		Location : PDU_level		<input type="button" value="Refresh Off"/>							
PDU ID	Model	PDU Location	Status	Total Load	Circuit A			Circuit B			
					Max	Load	Alarm	Max	Load	Alarm	
01	V16-IEC32A / MT	New_location	Normal	0 A	16 A	0 A	<input type="text" value="13"/> A	16 A	0 A	<input type="text" value="13"/> A	
02	V16-IEC32A / MT	New_location	Normal	0 A	16 A	0 A	<input type="text" value="13"/> A	16 A	0 A	<input type="text" value="13"/> A	
03	V16-IEC32A / MT	New_location	Normal	0 A	16 A	0 A	<input type="text" value="13"/> A	16 A	0 A	<input type="text" value="13"/> A	
04	V16-IEC32A / MT	New_location	Normal	0 A	16 A	0 A	<input type="text" value="13"/> A	16 A	0 A	<input type="text" value="13"/> A	
05	V20-IEC16A / MT	New_location	Normal	0 A	16 A	0 A	<input type="text" value="13"/> A	--	--	<input type="text" value=""/> A	
06	V20-IEC16A / MT	New_location	Normal	0 A	16 A	0 A	<input type="text" value="13"/> A	--	--	<input type="text" value=""/> A	
07	V20-IEC16A / MT	New_location	Normal	0 A	16 A	0 A	<input type="text" value="13"/> A	--	--	<input type="text" value=""/> A	
08	V20-IEC16A / MT	New_location	Normal	0 A	16 A	0 A	<input type="text" value="13"/> A	--	--	<input type="text" value=""/> A	
09	V16-IEC16A / MT	New_location	Normal	0 A	16 A	0 A	<input type="text" value="13"/> A	--	--	<input type="text" value=""/> A	
10	V16-IEC16A / MT	New_location	Normal	0 A	16 A	0 A	<input type="text" value="13"/> A	--	--	<input type="text" value=""/> A	
11	V16-IEC16A / MT	New_location	Normal	0 A	16 A	0 A	<input type="text" value="13"/> A	--	--	<input type="text" value=""/> A	
12	V16-IEC16A / MT	New_location	Normal	0 A	16 A	0 A	<input type="text" value="13"/> A	--	--	<input type="text" value=""/> A	
13	V20-IEC32A / MT	New_location	Normal	0 A	16 A	0 A	<input type="text" value="13"/> A	16 A	0 A	<input type="text" value="13"/> A	
14	V20-IEC32A / MT	New_location	Normal	0 A	16 A	0 A	<input type="text" value="13"/> A	16 A	0 A	<input type="text" value="13"/> A	
15	V20-IEC32A / MT	New_location	Normal	0 A	16 A	0 A	<input type="text" value="13"/> A	16 A	0 A	<input type="text" value="13"/> A	
16	V20-IEC32A / MT	New_location	Normal	0 A	16 A	0 A	<input type="text" value="13"/> A	16 A	0 A	<input type="text" value="13"/> A	
<input type="button" value="Apply"/> <input type="button" value="Cancel"/>											

: save the changes

: quit without changes

## < Details >

- On / Off status of each outlet
- Remote on / off outlet ( MTS switched PDU only )
- Rename outlet device, PDU and location
- Aggregate current on the PDU

- Data refresh every 10 seconds
- Disable **Refresh** during data input

PDU ID:

PDU Location:  Refresh Off

Status: Normal

Loading: 0 / 20 A (Max.)

Outlet ID	Name	Status	Switch	Outlet ID	Name	Status	Switch
1	DeviceName_01	ON	OFF	13	DeviceName_13	OFF	ON
2	DeviceName_02	ON	OFF	14	DeviceName_14	OFF	ON
3	DeviceName_03	ON	OFF	15	DeviceName_15	OFF	ON
4	DeviceName_04	ON	OFF	16	DeviceName_16	OFF	ON
5	DeviceName_05	OFF	ON	17	DeviceName_17	OFF	ON
6	DeviceName_06	OFF	ON	18	DeviceName_18	OFF	ON
7	DeviceName_07	OFF	ON	19	DeviceName_19	OFF	ON
8	DeviceName_08	OFF	ON	20	DeviceName_20	OFF	ON
9	DeviceName_09	OFF	ON	21	DeviceName_21	OFF	ON
10	DeviceName_10	OFF	ON	22	DeviceName_22	OFF	ON
11	DeviceName_11	OFF	ON	23	DeviceName_23	OFF	ON
12	DeviceName_12	OFF	ON	24	DeviceName_24	OFF	ON

- : save the changes       : restart the PDU meter ( outlets are still activated )
- : reload the PDU information

## < Setup >

**Configuration**

IP Dongle Device:

Password:

Location:

**Network setting**

DHCP:

IP Address:

Subnet:

Gateway:

Port:

Serial No:

MAC Address:

Firmware Version:

- IP dongle configuration setting
- Password setting
- Network setting
- Hardware information provided

- : save the changes
- : reload the IP dongle to factory default ( Press **Default** > **Apply** )
- : restart the IP dongle

The company reserves the right to modify product specifications without prior notice and assumes no responsibility for any error which may appear in this publication.

All brand names, logo and registered trademarks are properties of their respective owners.

Copyright 2011 Austin Hughes Electronics Ltd. All rights reserved.