

## User Manual 17" FHD 1080p LCD

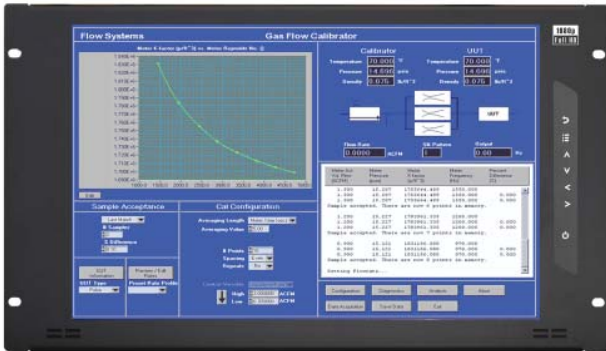

### RP-F617

#### 6U Rackmount Display Panel

**1080p  
Full HD**

#### Options :

- SDI / MCS
- AV / HDMI / Audio
- Touchscreen / DC power
- MIL-type or lockable connector



Designed and manufactured by Austin Hughes

751

## Legal Information

First English printing, January 2019

Information in this document has been carefully checked for accuracy; however, no guarantee is given to the correctness of the contents. The information in this document is subject to change without notice. We are not liable for any injury or loss that results from the use of this equipment.

## Safety Instructions

**Please read all of these instructions carefully before you use the device. Save this manual for future reference.**

- Unplug equipment before cleaning. Don't use liquid or spray detergent; use a moist cloth.
- Keep equipment away from excessive humidity and heat. Preferably, keep it in an air-conditioned environment with temperatures not exceeding 40° Celsius (104° Fahrenheit).
- When installing, place the equipment on a sturdy, level surface to prevent it from accidentally falling and causing damage to other equipment or injury to persons nearby.
- When the equipment is in an open position, do not cover, block or in any way obstruct the gap between it and the power supply. Proper air convection is necessary to keep it from overheating.
- Arrange the equipment's power cord in such a way that others won't trip or fall over it.
- If you are using a power cord that didn't ship with the equipment, ensure that it is rated for the voltage and current labeled on the equipment's electrical ratings label. The voltage rating on the cord should be higher than the one listed on the equipment's ratings label.
- Observe all precautions and warnings attached to the equipment.
- If you don't intend on using the equipment for a long time, disconnect it from the power outlet to prevent being damaged by transient over-voltage.
- Keep all liquids away from the equipment to minimize the risk of accidental spillage. Liquid spilled on to the power supply or on other hardware may cause damage, fire or electrical shock.
- Only qualified service personnel should open the chassis. Opening it yourself could damage the equipment and invalidate its warranty.
- If any part of the equipment becomes damaged or stops functioning, have it checked by qualified service personnel.

## What the warranty does not cover

- Any product, on which the serial number has been defaced, modified or removed.
- Damage, deterioration or malfunction resulting from:
  - Accident, misuse, neglect, fire, water, lightning, or other acts of nature, unauthorized product modification, or failure to follow instructions supplied with the product.
  - Repair or attempted repair by anyone not authorized by us.
  - Any damage of the product due to shipment.
  - Removal or installation of the product.
  - Causes external to the product, such as electric power fluctuation or failure.
  - Use of supplies or parts not meeting our specifications.
  - Normal wear and tear.
  - Any other causes which does not relate to a product defect.
- Removal, installation, and set-up service charges.

## Regulatory Notices Federal Communications Commission (FCC)

This equipment has been tested and found to comply with the limits for a Class B digital device, pursuant to Part 15 of the FCC rules. These limits are designed to provide reasonable protection against harmful interference in a residential installation.

Any changes or modifications made to this equipment may void the user's authority to operate this equipment. This equipment generates, uses, and can radiate radio frequency energy and, if not installed and used in accordance with the instructions, may cause harmful interference to radio communications.

However, there is no guarantee that interference will not occur in a particular installation. If this equipment does cause harmful interference to radio or television reception, which can be determined by turning the equipment off and on, the user is encouraged to try to correct the interference by one or more of the following measures:

- Re-position or relocate the receiving antenna.
- Increase the separation between the equipment and receiver.
- Connect the equipment into an outlet on a circuit different from that to which the receiver is connected.

# Contents

## < Part. 1 > RP-F617

1.1	Package Content	P.1
1.2	Structure Diagram & Dimension	P.1 - 2
1.3	Installation	P.3

## < Part. 2 > Specifications / OSD / Remote Controller

2.1	Product Specifications	P.4 - 5
2.2	On-screen Display Operation ( OSD )	P.6 - 7

## < Part. 3 > Options

3.1	3G / HD / SD- <b>SDI</b> Broadcast-grade input	P.8
3.2	<b>MCS</b> Multi-display control solution	P.9
3.3	<b>AV3.0</b> Upgrade : DVI-D + VGA + HDMI + BNC + S-Video + Audio	P.10
3.4	F17" Touchscreen : Resistive ( 1-point touch )	P.11
3.5	DC Power : 12V / 24V / 48V / 125V	P.12
3.6	MIL-type or lockable connector	P.13

## Before Installation

- It is very important to mount the equipment in a suitable cabinet or on a stable surface.
- Make sure the place has a good ventilation, is out of direct sunlight, away from sources of excessive dust, dirt, heat, water, moisture and vibration.

## Unpacking

The equipment comes with the standard parts shown in package content. Check and make sure they are included and in good condition. If anything is missing, or damaged, contact the supplier immediately.

## How To Clean Your LCD Monitor



### Caution :

- To avoid the risk of electric shock, make sure your hands are dry before unplugging your monitor from or plugging your monitor into an electrical outlet.
- When you clean your monitor, do not press down on the LCD screen. Pressing down on the screen can scratch or damage your display. Pressure damage is not covered under warranty.
- Use only cleansers made specifically for cleaning monitors and monitor screens. Cleansers not made to clean monitors and monitor screens can scratch the LCD display or strip off the finish.
- Do not spray any kind of liquid directly onto the screen or case of your monitor. Spraying liquids directly onto the screen or case can cause damage which is not covered under warranty.
- Do not use paper towels or abrasive pads to clean your monitor. Using an abrasive pad or any wood based paper product such as paper towels can scratch your LCD screen.

## Cleaning Your Monitor

To clean your LCD safely, please follow these steps :

- ① Disconnect the power cord.
- ② Gently wipe the surface using a clean, dry microfiber cloth. Use as little pressure as possible.

## Cleaning Tough Marks and Smudges

To remove tough marks and smudges, please follow these steps :

- ① Disconnect the power cord.
- ② Spray a small amount of non-abrasive cleanser on a microfiber cloth.



**Caution : Do not spray or apply any liquids directly onto the monitor. Always apply the solution to your microfiber cloth first, not directly on the parts you are cleaning.**

- ③ Gently wipe the surface. Use as little pressure as possible.
- ④ Wait until your monitor is completely dry before plugging it in and powering it up.

< Part 1 >

< 1.1 > Package Content

RP-F617

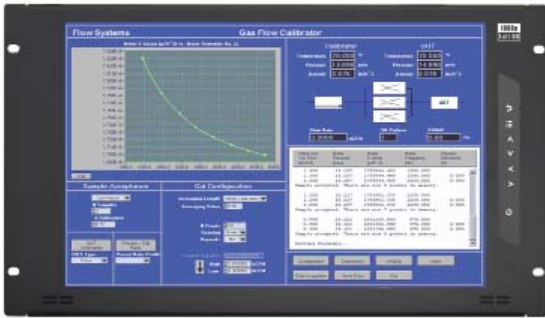

**RP-F617 unit X 1**

- 6ft VGA cable X 1
- Power adapter X 1
- Power cord X 1

< 1.2 > Structure Diagram

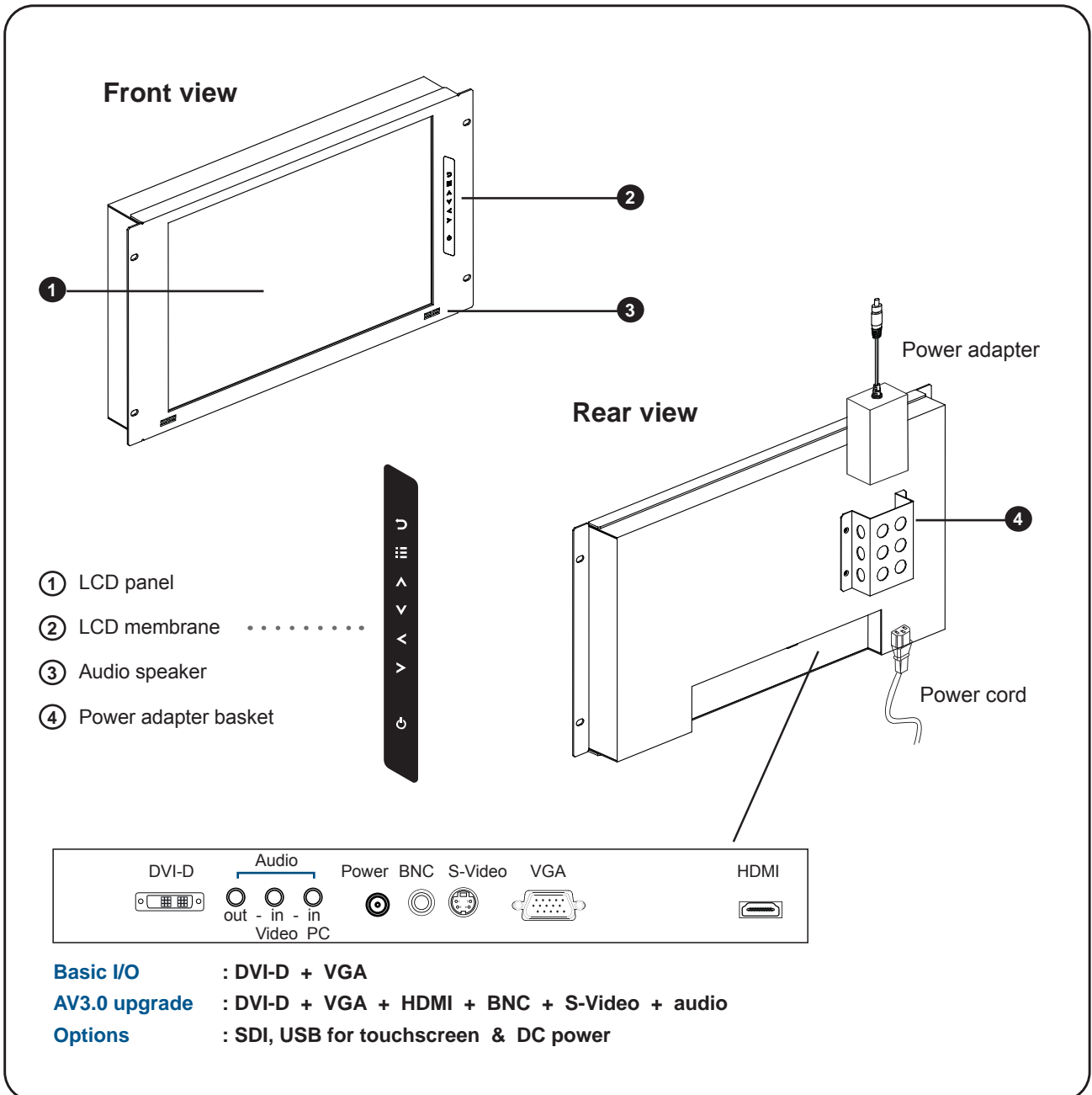

## < 1.2 > Dimension

Front View

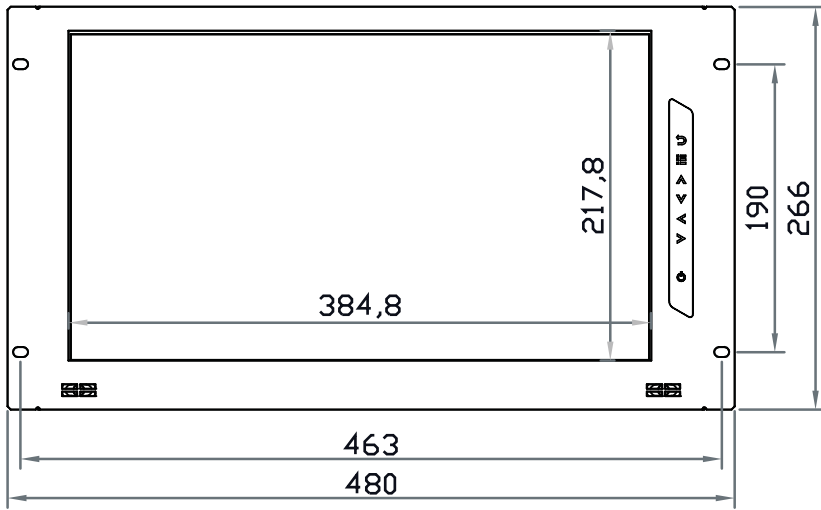

Side View

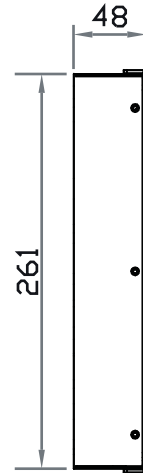

Bottom View

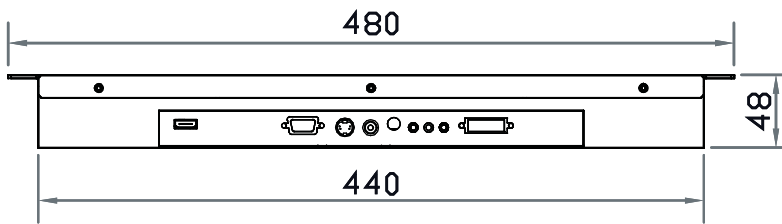

UNIT : mm  
1mm = 0.03937 inch

Model	Product Dimension (W x D x H)	Packing Dimension (W x D x H)	Net Weight	Gross Weight
RP-F617	480 x 48 x 266 mm 18.9 x 1.9 x 10.5 inch	529 x 124 x 451 mm 20.8 x 4.9 x 17.8 inch	4.5 kg 9.9 lb	6 kg 13.2 lb

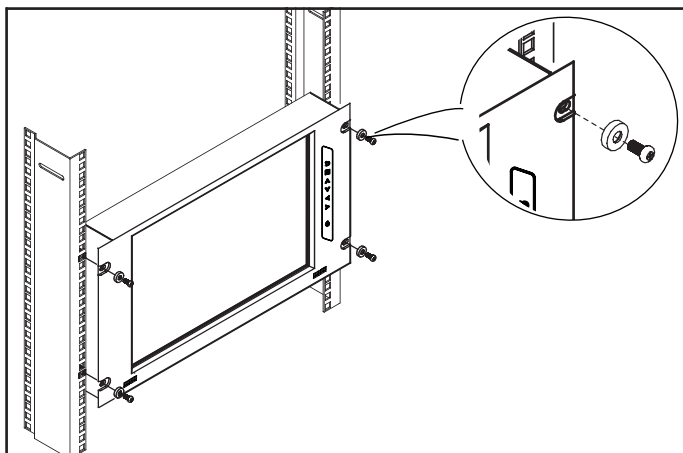

**Step 1**

- Mount the display panel with M6 screw set.
  - M6 screw x 4 pcs required ( Left & right side ).
- M6 screw sets are not provided.**

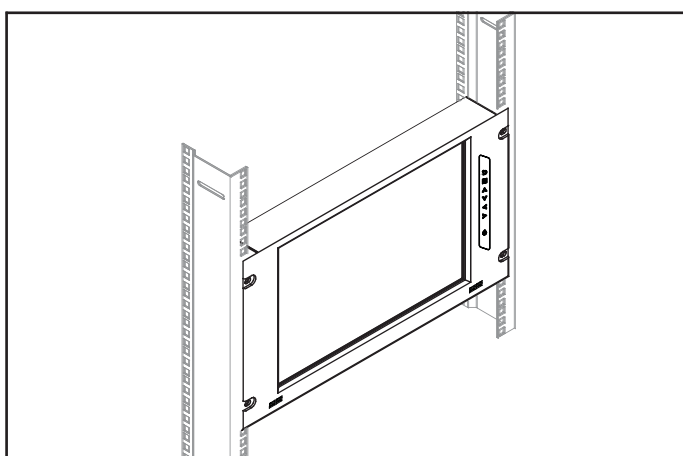

**Step 2**

- Fix the LCD into the rack.

## < Part 2 >

### < 2.1 > Product Specifications

<b>LCD Panel</b>	Panel Size ( diagonal )	17.3-inch Widescreen TFT color LCD
	Display pixel ( dots x lines )	1920 x 1080
	Brightness ( typ. )	400
	Contrast Ratio ( typ. )	600:1
	Color	16.7 M, 8-bit
	Viewing Angle ( L/R/U/D )	80/80/60/80
	Response Time ( ms )	5.5
	Dot pitch ( mm )	0.1989
	Display Area ( mm )	381.888H x 214.812V
	Surface treatment	Anti-glare, Hard-coating
	Surface hardness	3H
	Backlight Type	LED
	MTBF ( hrs )	50,000

<b>Video Connectivity</b>	Digital	HDMI	HDMI 1.4, CEA-861-E
		DVI	DVI-D, TMDS single link
	Analog	VGA	Analog 0.7Vp-p
		Composite ( BNC )	NTSC & PAL
		S-Video ( 4-pin )	NTSC & PAL
	Plug & Play	DVI / VGA	VESA EDID structure 1.3
	Synchronization	VGA	Separate, Composite & SOG

<b>Audio Connectivity</b>	Audio Input	Connector	3.5mm stereo jack
		Impedance / Power level	30k $\Omega$ / 750mV
	Audio Output	Connector	3.5mm stereo jack
		Resistance / Power level	30k $\Omega$ / 2.8V
		Speaker	Dual Stereo Speaker
			2W x 2

\*When the audio output is connected, speaker output is OFF

<b>Power</b>	Power Supply	Range	Auto-sensing 100 to 240VAC, 50 / 60Hz
	Power Consumption	Screen ON	Max. 25W
		Power saving mode	Max. 4W
		Power button OFF	Max. 1W

<b>Regulatory</b>	Safety	FCC & CE certified
	Environmental	RoHS2 & REACH compliant









<b>Environmental Conditions</b>	Operating	Temperature	0 to 55°C degree
		Humidity	20~90%, non-condensing
		Altitude	16,000 ft
	Storage / Non-operating	Temperature	-20 to 60°C degree
		Humidity	5~90%, non-condensing
		Altitude	40,000 ft
		Shock	10G acceleration (11ms duration)
		Vibration	5~500Hz 1G RMS random

<b>Physical Specification</b>	Product ( W x D x H )	480 x 48 x 266 mm 18.9 x 1.9 x 10.5 inch
	Packing ( W x D x H )	529 x 124 x 451 mm 20.8 x 4.9 x 17.8 inch
	Net Weight	4.5 kgs / 9.9 lbs
	Gross Weight	6 kgs / 13.2 lbs

<b>Applicable Format</b>	DVI-D / VGA Input	PC Signal	1920 x 1080 x 60Hz
			1360 x 768 x 60Hz
			1280 x 1024 x 60 / 75Hz
			1280 x 960 x 60Hz
			1280 x 768 x 60 / 75Hz
			1152 x 864 x 75Hz
			1024 x 768 x 60 / 70 / 75Hz
			848 x 480 x 60Hz
			800 x 600 x 60 / 72 / 75Hz
			720 x 400 x 70Hz
			640 x 480 x 60 / 72 / 75Hz
			640 x 400 x 70Hz
	640 x 350 x 70Hz		
	HDMI Input	PC Signal	3840 x 2160 x 60Hz
			HDMI 1.4
Audio Signal		2ch Linear PCM	



## < 2.2 > On-screen Display Operation ( OSD )



Membrane Switch	Function
	Turn the monitor on or off
	Display the OSD menu Act as an Enter key to select screen setting options
   	Scroll through menu options and adjust the displayed control
	Exit the OSD screen Go back to the previous on-screen sub-menu or main menu

Remark : All LED touch buttons in **WHITE** light.

The LED of **Power**  touch button will flash continuously when there is no signal input.

- ① All the LED touch buttons will automatically turn off after 10 minutes of idle status ( except the **Power**  ).
- ② Light up all membrane buttons, please press any button for 1 - 2 seconds ( except the **Power**  ).

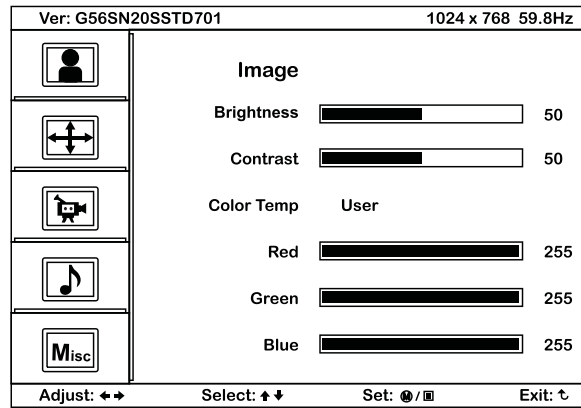

**OSD Configuration Page**



**Image:**

for the brightness, contrast, color temp, red, green, and blue

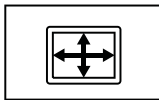

**Geometry:**

for the auto adjust, H position, V position, phase and clock



**Video:**

for the colour, tint, sharpness, noise reduction, DCDi and TV Setup



**Audio:**

for volume, bass, treble, balance, AVL and mute



**Misc:**

for the language, OSD position, graphic mode, ratio, reset and timer

## < Part 3 >

### < 3.1 > Options : 3G / HD / SD-SDI input



Austin Hughes' SDI input is an ideal solution for the broadcast-grade video and high resolution CCTV market.

Designed for use with CyberView displays, a SDI input module can support up to 1080p @60Hz resolution without using additional space or power and it comes standard with a 2-year warranty.

#### SDI

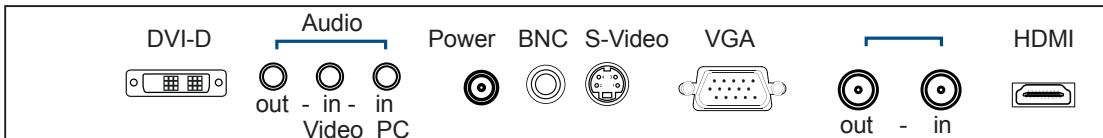

\*\*\* For **SDI** option, the AD board will be upgraded to AV3.0, and this comes standard with HDMI, DVI-D, VGA, S-Video, BNC and audio inputs.

<b>INPUT</b>	3G-SDI IN	BNC x 1 / 0.8Vp-p ( 75 ohm )
	3G-SDI OUT	BNC x 1 / Active through, equalized & relocked

<b>Standard Compliance</b>	Video	SMPTE 425M / 274M / 296M / 125M ITU-R BT.656
	Audio	SMPTE 299M / 272M-C

<b>Compatible Video Format</b>	3G-SDI	1080p @60 / 50Hz, 4:2:2 1080p @30 / 25 / 24Hz, 4:4:4 1080i @60 / 50Hz, 4:4:4 720p @60 / 50Hz, 4:4:4
	HD-SDI	1080p @30 / 25 / 24Hz, 4:2:2 1080i @60 / 50Hz, 4:2:2 720p @60 / 50Hz, 4:2:2
	SD-SDI	480i @60Hz, 4:2:2
	ITU-R BT.656	576i @50Hz, 4:2:2

<b>Compatible Audio Format</b>	3G-SDI	48kHz, 16 / 20 / 24 bit, 2 CH, Synchronized Video
	HD-SDI	48kHz, 16 / 20 / 24 bit, 2 CH, Synchronized Video
	SD-SDI	48kHz, 16 / 20 / 24 bit, 2 CH, Synchronized / Asynchronized Video

<b>Max. Transmission Distance 75 ohm coaxial cable</b>	3G-SDI	150m at 2.97Gb/s
	HD-SDI	250m at 1.485Gb/s
	SD-SDI	480m at 270Mb/s

## < 3.2 > Options : MCS ( Multi-display Control )

RP-F617



More control is always good. Especially when it is necessary and easy. Austin Hughes provides MCS solution to control the **OSD** of various CyberView LCD display up to 64 units.

The RS-232C is used for the communication between the PC and the first display via a 15 feet serial cable while the CAN bus is used for the various LCD displays cascade together via CAT 5/6 cable, and daisy chain up to 1,000 meters.

Designed for use with CyberView LCD displays, Austin Hughes provides a MCS input module without using additional space or power and it comes standard with a 2-year warranty.

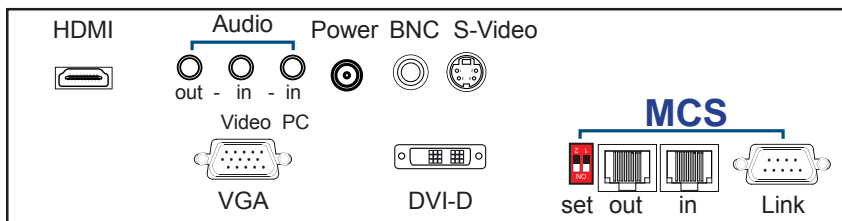

\*\*\* Please download the protocol of MCS control at :  
<http://www.austin-hughes.com/support/usermanual/cyberview/UM-CV-MCS.pdf>

\*\*\* For **MCS** option, casing depth will be changed.

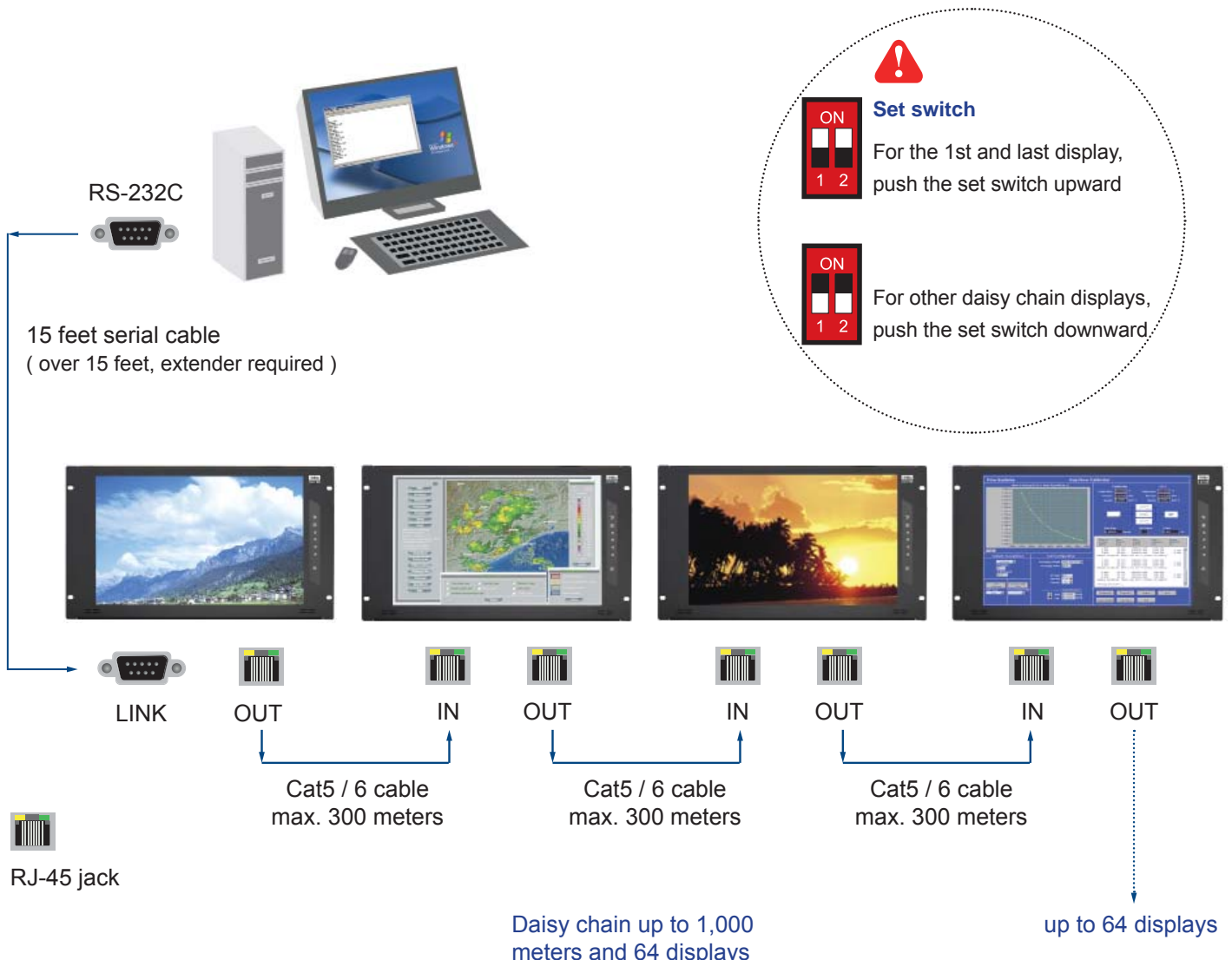

### < 3.3 > AV3.0 Upgrade Options :

- **HDMI** ( HDMI 1.4, CEA-861-E )
- **AV** ( S-Video + Composite, BNC )
- **Audio** ( Built-in Dual Stereo Speakers, 2W x 2 )  
( 3.5mm audio jacks for audio in & out )



( 1 ) In some circumstances, if the user connects the LCD to PC via HDMI port for video and audio signals, the LCD may display incorrectly on a full screen. If so, please adjust the display card setting on display size to fix the issue.

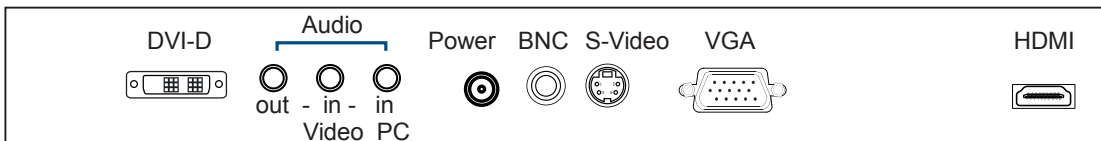



F17" USB Touchscreen Specification

Model	TRB e-Resistive
Technology	5-Wire Resistive
Touch Point	Single
Method	Stylus or Finger
Activation Force	≤ 50g / Stylus=R0.8
Durability	10 million touches
Response Time	15 ms
Optical Transmittance	80% ± 3%
Surface Hardness	3H
Haze	8% ± 3%
Glass	2.2 ±0.2 mm
Connector	USB Type A
Compatibility	Windows 7 / XP / Vista, Linux

- USB touchscreen package includes 1 x 6ft USB cable, quick reference guideline and CD disc
- For detailed information, please refer to the attached CD disc
- As the touchscreen unit is not made of toughened glass, please handle it carefully

USB Touchscreen

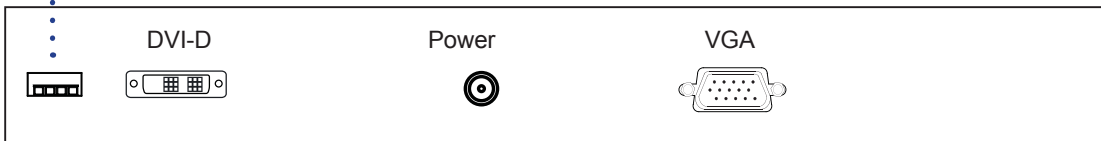

Please follow the below steps to setup the touch screen:-

- Step 1.** Run the bundled CD disc or download the driver from the link below : <http://www.austin-hughes.com/resources/driver/rackmount-display>
- Step 2.** Double click the Setup.exe
- Step 3.** Follow the installation instruction to finish the setup
- Step 4.** After installation, run the TouchKit program & the “4 point calibration”



Please do the initial calibration after the first setup

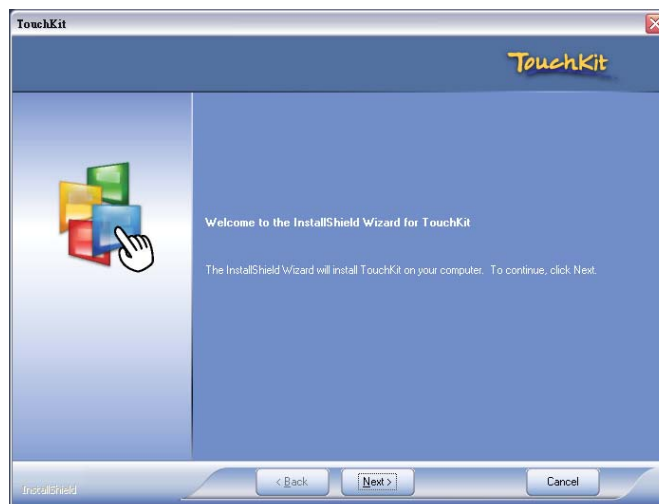

### < 3.5 > Options : DC Power

Model	12V	24V	48V	125V
<b>Input rating</b>				
Input voltage:	12-Volt	24-Volt	48-Volt	110-Volt
Input range:	9 ~ 18V	18 ~ 36V	36 ~ 75V	66 ~ 160V
Input current				
- No load	50 mA	50 mA	50 mA	35 mA
- Full load	4950 mA	2450 mA	1220 mA	749 mA
<b>Output rating</b>				
Output voltage:	12-Volt	12-Volt	12-Volt	12-Volt
Output current:	4.16A	4.16A	4.16A	6.25A
<b>Efficiency</b>	84%	85%	85%	91%



\*\*\* For DC power option :

( 1 ) If the unit with LCD, earthing may be required 



	Input	Part no.	MIL Standard
<b>MIL - type Connector</b>	DC Power *** ( Male )	MS3470W8-33P 	MIL - DTL - 26482
	VGA *** ( Male )	MS3470W14-15P 	MIL - DTL - 26482

\*\*\* There are several additional MIL DC and VGA connector types with varying design characteristics to meet cost considerations and to provide users with the most design flexibility possible. For more information, please contact us.

	Input	Part no.	Standard
<b>Lockable Connector</b>	DC Power ( Male )	YM-Ext-461CP001 	D-type 3W3
	USB	LUSB - A111 - 00 	-

\*\*\* MIL - type or Lockable connectors above can be integrated with our LCD displays. Sale service just for connectors not provided.

Intentionally  
Left  
Blank

Intentionally  
Left  
Blank

The company reserves the right to modify product specifications without prior notice and assumes no responsibility for any error which may appear in this publication.

All brand names, logo and registered trademarks are properties of their respective owners.

Copyright 2019 Austin Hughes Electronics Ltd. All rights reserved.