

User Manual Utilities ISU-01

S-800 Standalone Cabinet SmartCard Handle



Designed and manufactured by Austin Hughes



REACH

Intentionally Left Blank

Legal Information

First English printing, November 2020

Information in this document has been carefully checked for accuracy; however, no guarantee is given to the correctness of the contents. The information in this document is subject to change without notice. We are not liable for any injury or loss that results from the use of this equipment.

Safety Instructions

Please read all of these instructions carefully before you use the device. Save this manual for future reference.

- Unplug equipment before cleaning. Don't use liquid or spray detergent; use a moist cloth.
- Keep equipment away from excessive humidity and heat. Preferably, keep it in an air-conditioned environment with temperatures not exceeding 40° Celsius (104° Fahrenheit).
- When installing, place the equipment on a sturdy, level surface to prevent it from accidentally falling and causing damage to other equipment or injury to persons nearby.
- When the equipment is in an open position, do not cover, block or in any way obstruct the gap between it and the power supply. Proper air convection is necessary to keep it from overheating.
- Arrange the equipment's power cord in such a way that others won't trip or fall over it.
- If you are using a power cord that didn't ship with the equipment, ensure that it is rated for the voltage and current labelled on the equipment's electrical ratings label. The voltage rating on the cord should be higher than the one listed on the equipment's ratings label.
- Observe all precautions and warnings attached to the equipment.
- If you don't intend on using the equipment for a long time, disconnect it from the power outlet to prevent being damaged by transient over-voltage.
- Keep all liquids away from the equipment to minimize the risk of accidental spillage. Liquid spilled on to the power supply or on other hardware may cause damage, fire or electrical shock.
- Only qualified service personnel should open the chassis. Opening it yourself could damage the equipment and invalidate its warranty.
- If any part of the equipment becomes damaged or stops functioning, have it checked by qualified service personnel.

What the warranty does not cover

- Any product, on which the serial number has been defaced, modified or removed.
- Damage, deterioration or malfunction resulting from:
 - Accident, misuse, neglect, fire, water, lightning, or other acts of nature, unauthorized product modification, or failure to follow instructions supplied with the product.
 - Repair or attempted repair by anyone not authorized by us.
 - Any damage of the product due to shipment.
 - Removal or installation of the product.
 - Causes external to the product, such as electric power fluctuation or failure.
 - Use of supplies or parts not meeting our specifications.
 - Normal wear and tear.
 - Any other causes which does not relate to a product defect.
- Removal, installation, and set-up service charges.

Regulatory Notices Federal Communications Commission (FCC)

This equipment has been tested and found to comply with the limits for a Class A digital device, pursuant to Part 15 of the FCC rules. These limits are designed to provide reasonable protection against harmful interference in business, industrial and commercial environments.

Any changes or modifications made to this equipment may void the user's authority to operate this equipment. This equipment generates, uses, and can radiate radio frequency energy and, if not installed and used in accordance with the instructions, may cause harmful interference to radio communications.

However, there is no guarantee that interference will not occur in a particular installation. If this equipment does cause harmful interference to radio or television reception, which can be determined by turning the equipment off and on, the user is encouraged to try to correct the interference by one or more of the following measures:

- Re-position or relocate the receiving antenna.
- Increase the separation between the equipment and receiver.
- Connect the equipment into an outlet on a circuit different from that to which the receiver is connected.

Notice : The changes or modifications not expressly approved by the party responsible for compliance could void the user's authority to operate the equipment.

IMPORTANT NOTE: To comply with the FCC RF exposure compliance requirements, no change to the antenna or the device is permitted. Any change to the antenna or the device could result in the device exceeding the RF exposure requirements and void user's authority to operate the device.

Contents

< Part. 1 > Hardware

1.1	Package Contents	P.1
1.2	Overall Installation Diagram	P.2
1.3	S - 800 Handle Installation (Single Point / 2-Point Lock)	P.3
1.4	Door Sensor Installation (Inductive / IR / Mechanical)	P.10

< Part. 2 > Handle Usage & Operation

2.1	Two Important Notes	P.16
2.2	Handle Operation with Door Sensor	P.18
2.3	Handle Operation without Door Sensor	P.20

< Part. 3 > Hardware Specifications

3.1	S800	P.22
-----	------	------

< Part. 4 > Hardware Specifications

4.1	Software Features & Hardware Requirements	P.23
4.2	Supported OS Platform & Language	P.24
4.3	Utilities ISU-01 Download & Installation	P.25
4.4	Driver Installation for Data Input Cable	P.26

< Part. 5 > Software Usage

5.1	Initial Handle Configuration	P.30
5.2	Card Assignment	P.33

< Part. 6 > Software Usage

6.1	Export & Import Handle Configuration	P.34
-----	--------------------------------------	------

< Part. 7 > FAQ

P.36

< Part. 8 > Troubleshooting

P.37

< Part. 9 > Optional Accessories

P.38

< Part 1 > Hardware

< 1.1 > Package Contents

Unpacking

The equipment comes with the standard parts shown on the package contents. Check and make sure they are included and in good condition. If anything is missing, or damage, contact the supplier immediately.

S-800 Package Content

- 800 smart card handle, pair (MiFARE **OR** Proximity)
- Y-Power cable, 1 pc
- Activated smartcard, 1 pc
- 2.5A power adapter, 1 pc
- 6' Power cord, 1 pc
- Key, 1 pc
- Cable clip, 8 pcs

Patented and Worldwide
Patents Pending



Handle mounting screw set :

- Handle mounting bracket, 2 pcs
- M4 x 9mm screw, 4 pcs
- Square hole washer, 6 pcs
- Circle hole washer, 2 pcs
- M5 x 15mm screw, 2 pcs
- U bracket, 2 pcs
- M3 x 10mm screw, 4 pcs
- Extensions spigot, 2 pcs

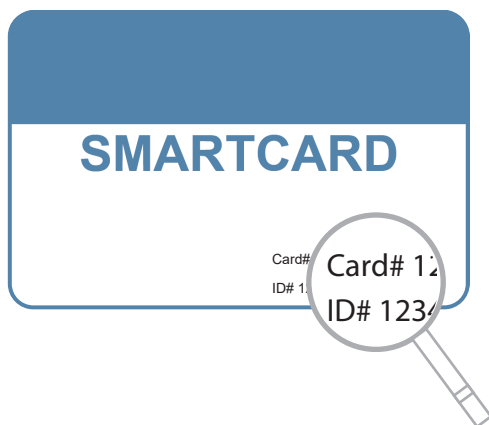

Each package bundled with activated smartcard x 1.
The card on the bottom right shows two information :

< 1 > Card number

< 2 > Handle ID number x 2 for two handles



This bundled smartcard has been activated in advance and authorized to unlock these two handles in the package.

< 1.2 > Overall Installation Diagram

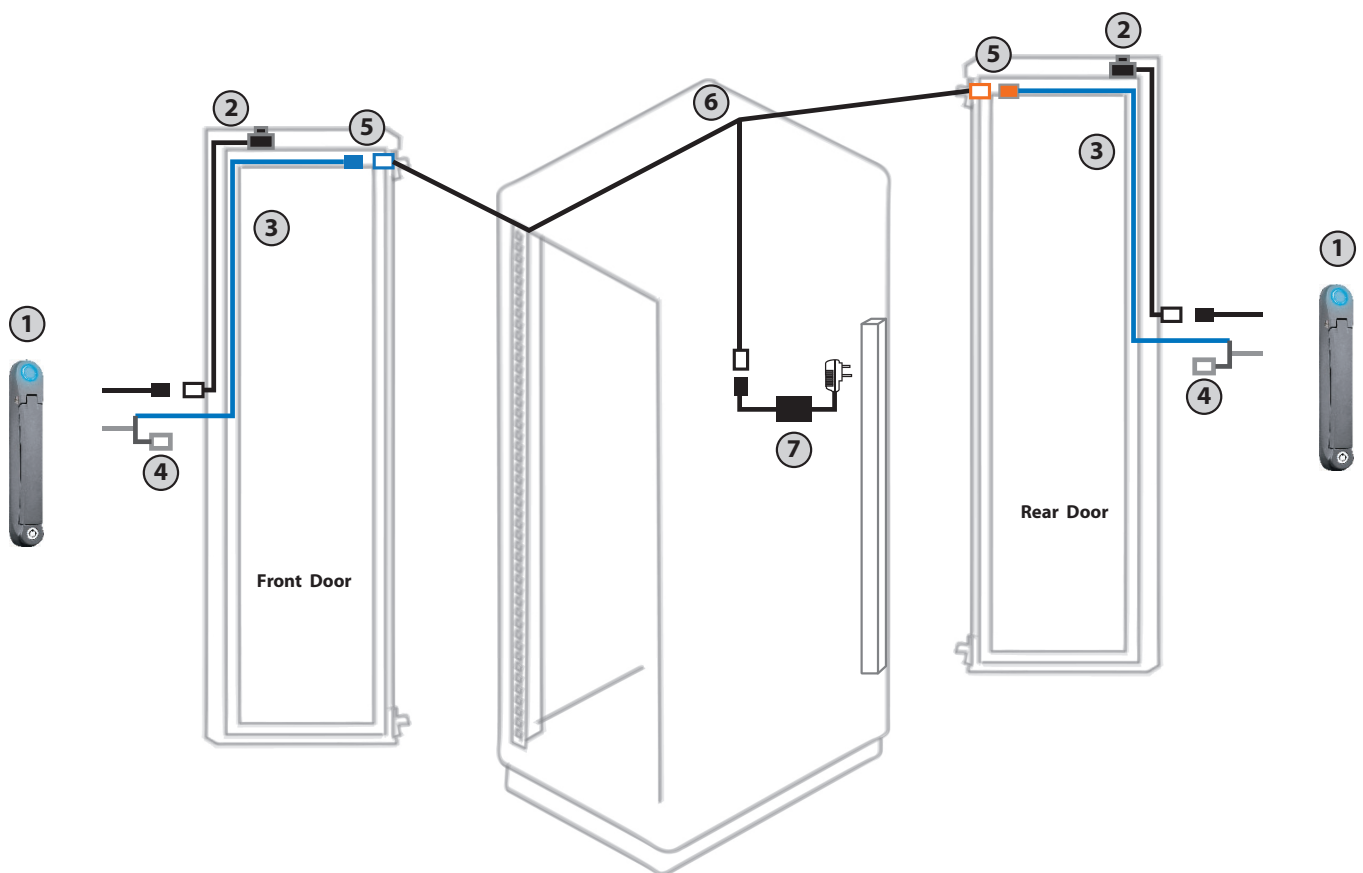

- ① S-800P Proximity / S-800M MiFARE SmartCard handle
- ② Optional door sensor with cable : 2pcs for front & rear door (2m)
- ③ Power cable (door section) : 2pcs for front & rear door (2m)
- ④ Data input connector (for handle activation / data input / configuration)
- ⑤ Joint connector of ③ & ⑥
- ⑥ Y-Power cable (cabinet section)
- ⑦ Universal Auto switching 2.5A power adapter & 6' power cord

< 1.3 > S - 800 Handle Installation Installation

To achieve the highest level of interoperability offered in the cabinet industry, the S-800 handle applies the universal mounting cut-out. It avoids costly and complicated door customization for the smartcard handle integration.

Universal Mounting Cut-out :

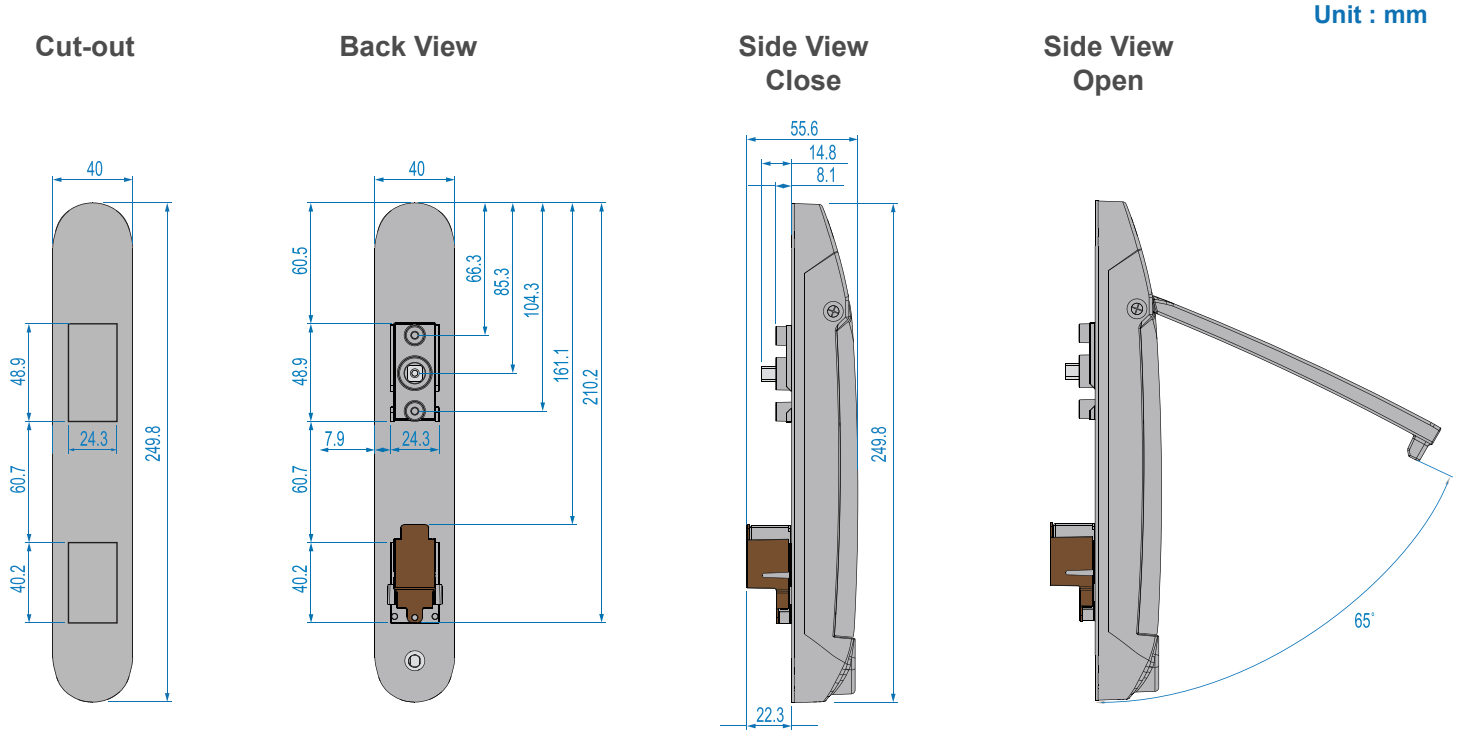

Handle Models of left / right side opening

S-800P / S-800M support left side open. If user requires right side open, please order S-800P-R / S-800M-R.

Model	Left side open	Right side open
S-800P	✓ Proximity	
S-800M	✓ MiFARE	
S-800P - R		✓ Proximity
S-800M - R		✓ MiFARE

< 1.3 > S - 800 Handle Installation

Installation for **Single Point Lock**

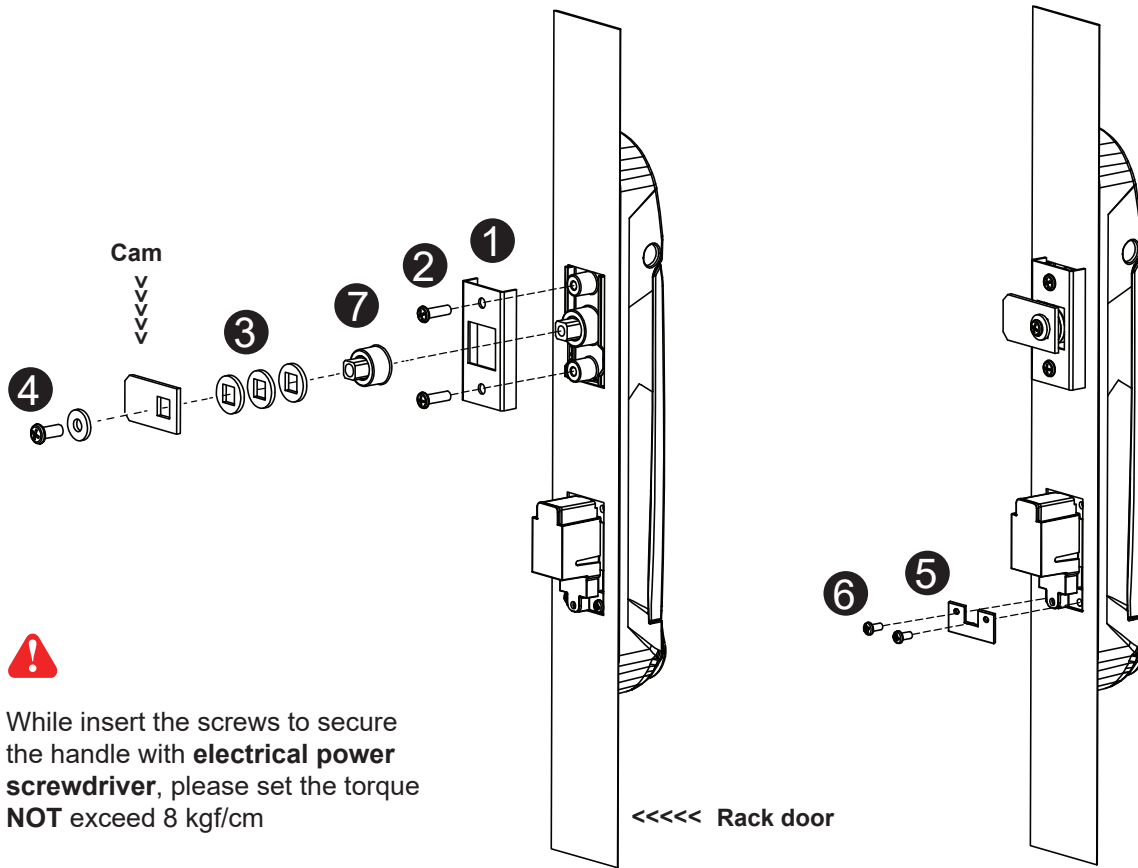

1. Mount the smartcard handle to the universal mounting position.
2. Place the **1** handle mounting bracket with **2** M4 x 9mm screw x 2 to secure the handle.
3. Attach the **Cam** with **3** square hole washer(s) to adjust and to fit the cam locking position. The extension spigot **7** required or not for installation is subject to the rack door locking design.
Note : - If the cam cannot fit the locking position after adjustment, customization for the cam is required.
- Cam customization service upon your request, please contact your sales representative.
4. Insert the **4** M5 x 15mm screw x 1 with circle hole washer to secure the **Cam** to the handle.
5. Place the **5** U bracket with **6** M3 x 10mm screw x 2 to further secure the handle in place.

Handle mounting screw set for single point lock

		Qty.	Single Point Lock
1	Handle mounting bracket	2	✓
2	M4 x 9mm screw for 1	4	✓
3	Square hole washer	6	✓
4	Circle hole washer w/ M5 x 15mm screw	2	✓
5	U bracket	2	✓
6	M3 x 10mm screw for 5	4	✓
7	Extensions spigot	2	✓



Pay attention to the following points when install the lock system.
Otherwise, it may cause handle distortion and malfunction.

1. Make sure
 - ① Cam lock can slide into the hole without stress.
 - ② The cut-out of the cam hole with enough space tolerance.



Cam lock hole
✓ enough
tolerance

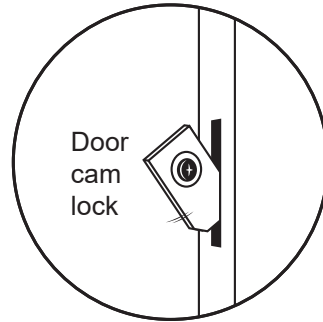

Cam lock hole
✗ limited
tolerance

2. Make sure the rack door is rigid and no bending.

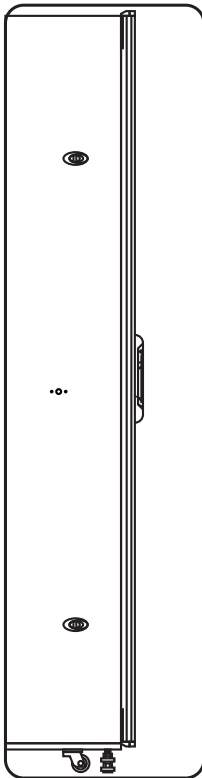

✓ Rigid
door

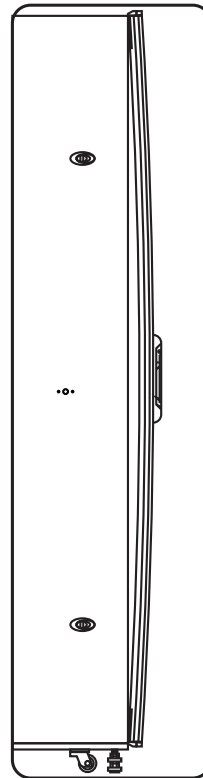

✗ Bending
door

3. Don't over tighten the fixing screws.

< 1.3 > S - 800 Handle Installation

Installation for **2-point Lock** (light-duty rod-latch)

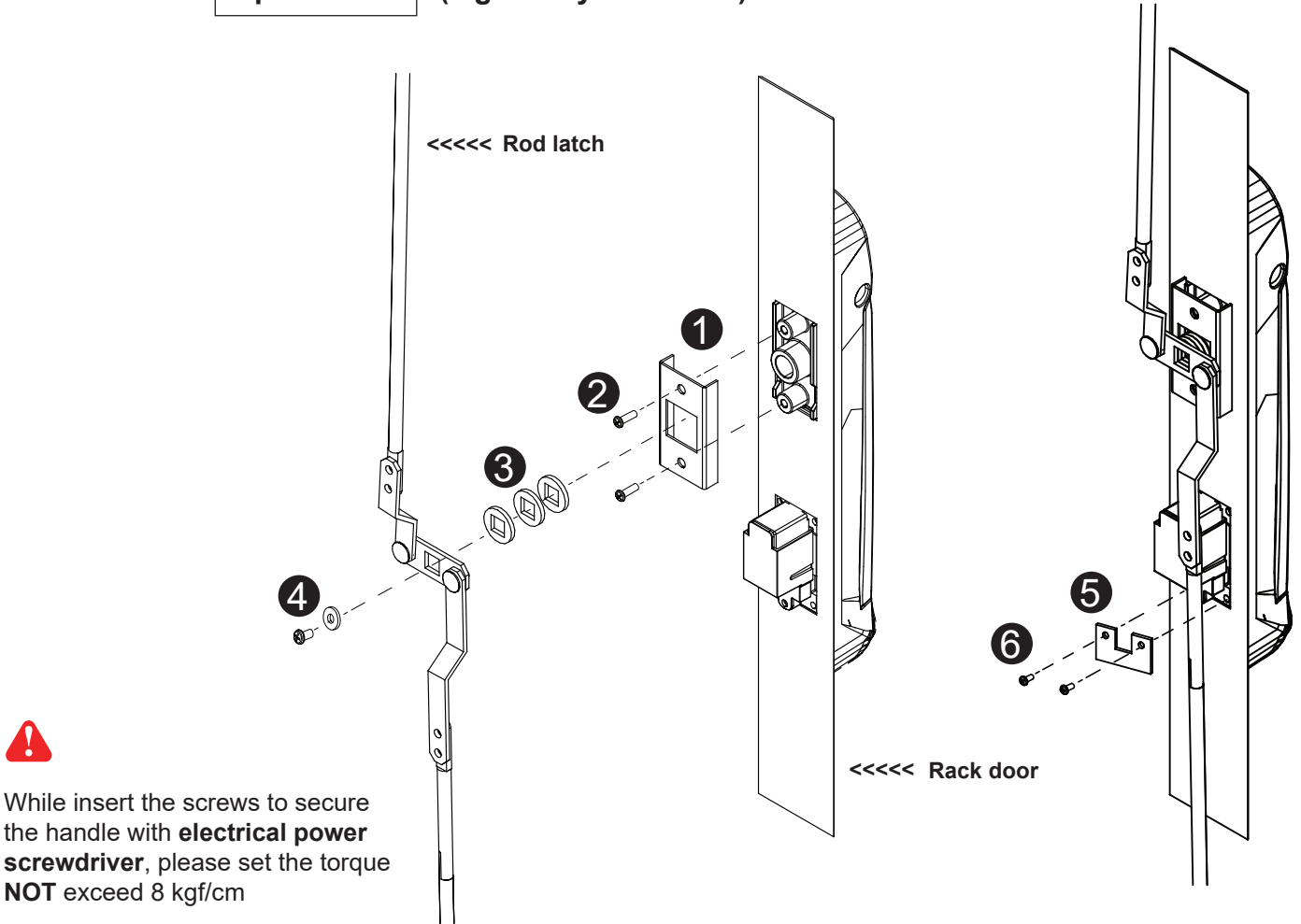

While insert the screws to secure the handle with **electrical power screwdriver**, please set the torque **NOT** exceed 8 kgf/cm

1. Mount the smartcard handle to the universal mounting position.
2. Place the **①** handle mounting bracket with **②** M4 x 9mm screw x 2 to secure the handle.
3. Attach the **Rod-latch** with **③** square hole washer(s) to adjust and to fit the door top & bottom locking position.
4. Insert the **④** M5 x 15mm screw x 1 with circle hole washer to secure the **Rod-latch** to the handle.
5. Place the **⑤** U bracket with **⑥** M3 x 10mm screw x 2 to further secure the handle in place.

Handle mounting screw set for 2-point lock (light-duty)

		Qty.	2-Point Lock light-duty
①	Handle mounting bracket	2	✓
②	M4 x 9mm screw for ①	4	✓
③	Square hole washer	6	✓
④	Circle hole washer w/ M5 x 15mm screw	2	✓
⑤	U bracket	2	✓
⑥	M3 x 10mm screw for ⑤	4	✓
⑦	Extensions spigot	2	X



Pay attention to the following points when install the lock system.
Otherwise, it may cause handle distortion and malfunction.

1. Make sure
 - ① Two ends of latch rod can entry into the top & bottom holes without stress.
 - ② The top & bottom holes with enough space tolerance.

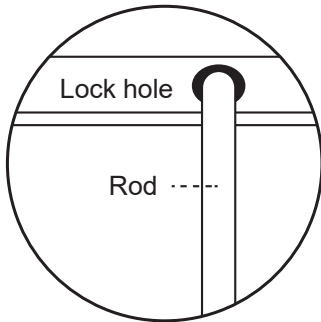

2-point lock holes
(top & bottom)

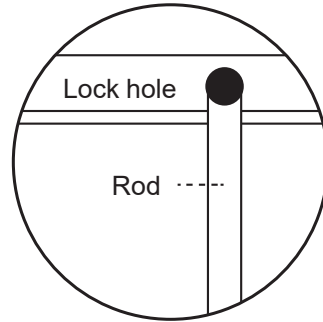

2-point lock holes
(top & bottom)

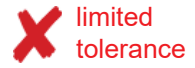

2. Make sure the rack door is rigid and no bending.

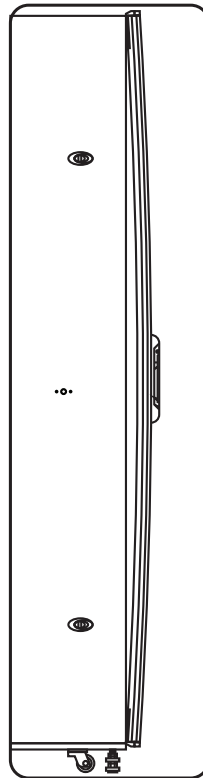
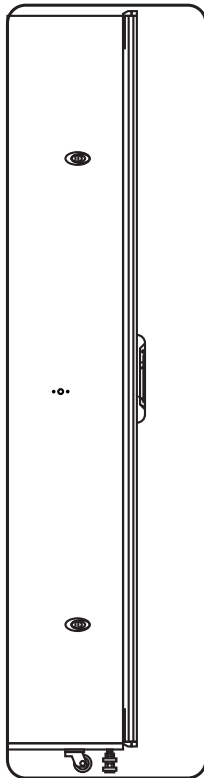

3. Don't over tighten the fixing screws.

< 1.3 > S - 800 Handle Installation

Installation for **2-point lock** (rod control system)

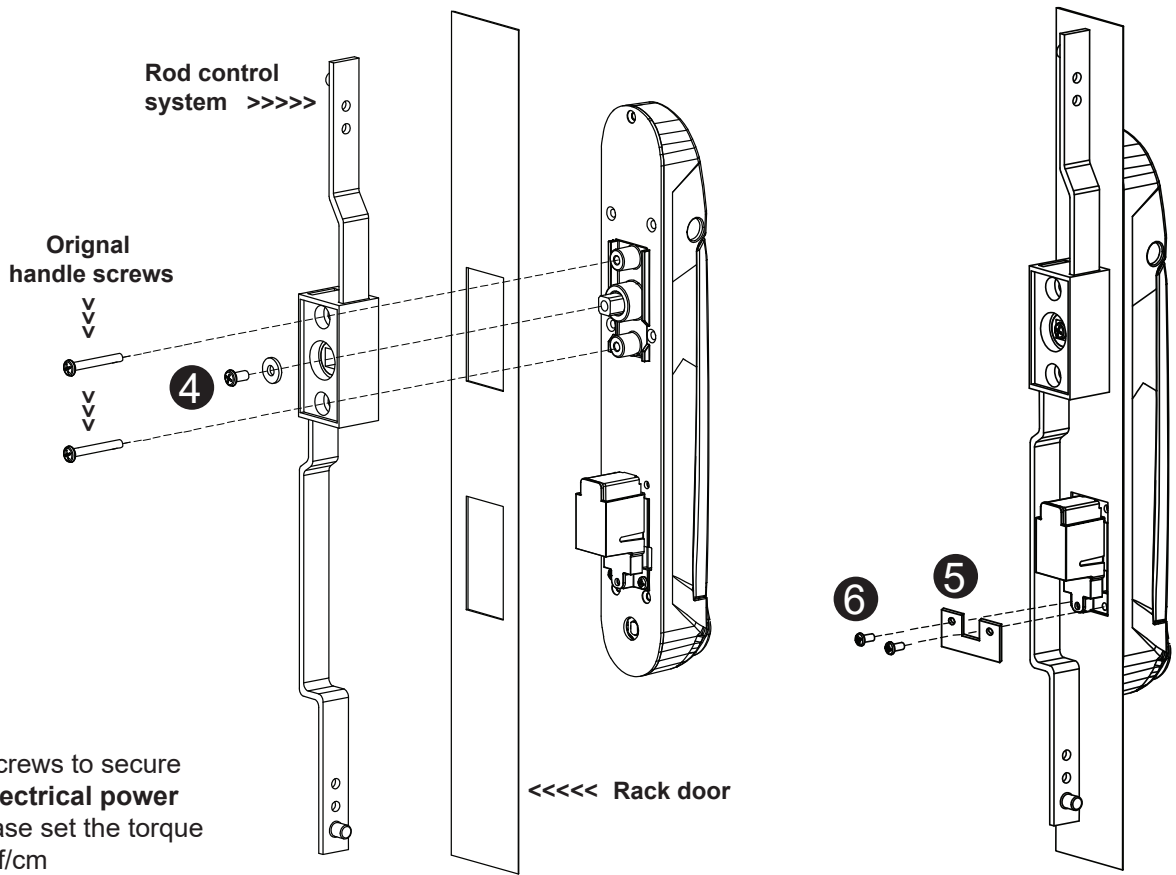

While insert the screws to secure the handle with **electrical power screwdriver**, please set the torque **NOT** exceed 8 kgf/cm

1. Mount the smartcard handle to the universal mounting position.
2. Attach the **Rod control system** to the handle and insert the **4** M5 x 15mm screw x 1 with circle hole washer to secure the position.
3. Insert **Original handle screws** x 2 through the **Rod control system** and door to the handle to fix it in place.
4. Place the **5** U bracket with **6** M3 x 10mm screw x 2 to further secure the handle in place.

Handle mounting screw set for 2-Point Lock (with rod control)

		Qty.	2-Point Lock (with rod control)
1	Handle mounting bracket	2	X
2	M4 x 9mm screw for 1	4	X
3	Square hole washer	6	X
4	Circle hole washer w/ M5 x 15mm screw	2	✓
5	U bracket	2	✓
6	M3 x 10mm screw for 5	4	✓
7	Extensions spigot	2	X



Pay attention to the following points when install the lock system.
Otherwise, it may cause handle distortion and malfunction.

1. Make sure
 - ① Two ends of latch rod can entry into the top & bottom holes without stress.
 - ② The top & bottom holes with enough space tolerance.

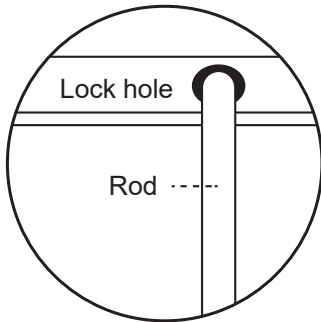

2-point lock holes
(top & bottom)

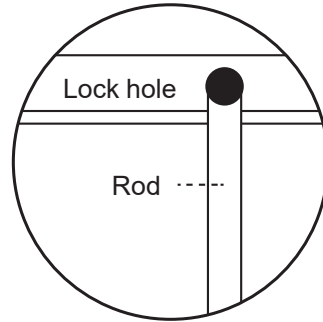

2-point lock holes
(top & bottom)

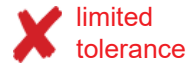

2. Make sure the rack door is rigid and no bending.

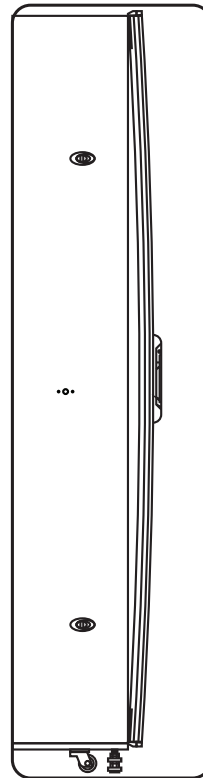
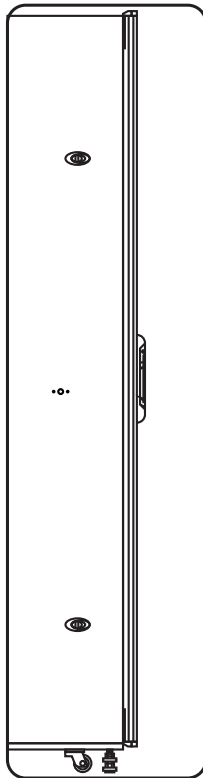

3. Don't over tighten the fixing screws.

< 1.4 > Door Sensor Installation Inductive Sensor

Optional door sensor is an essential accessories as users can be alerted by visual and audio alarm for unauthorized access.

Inductive Door Sensor, pair (S-DSI)



Features

- light weight
- mini size (32.5 x 12.2 x 9.2 mm)

Requirement

- cabinet frame made of iron
- sensing distance 3mm

Package content

- Inductive sensor w/ 2m cable x 2
- 2mm adhesive tape x 6
- Mounting bracket x 2

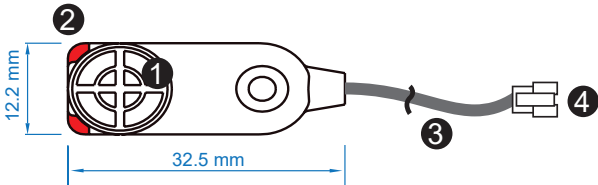

①	Sensor area
②	Red LED (light up while door opening)
③	2m cable
④	Cable jack (connect to handle)

Mounting by adhesive tape (no custom cutting required on door)

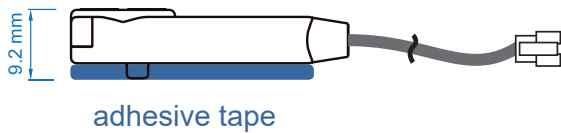

Mounting by bundled bracket

- Ø6.5mm hole cutting required on door frame

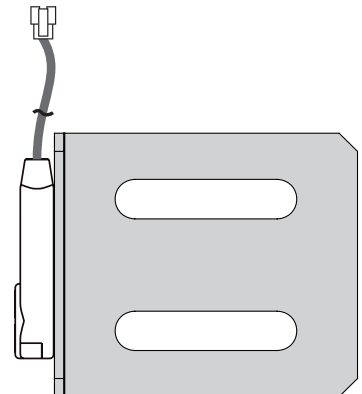
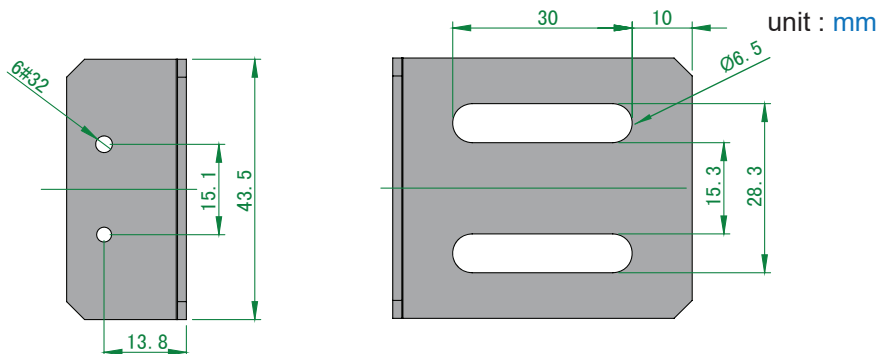

Installation steps

- connect to the handle
- guide & fix the cable with cable clips (bundle with handle package)
- place the sensor at the top of the door, close to the opening side
- adjust the sensor with adhesive tape or mounting bracket to ensure the sensing distance between door to frame within 3mm while door in close status



Sensor Operation

DOOR CLOSE

- close door
- inductive sensor detects the cabinet frame
- DOOR CLOSE SIGNAL sends out

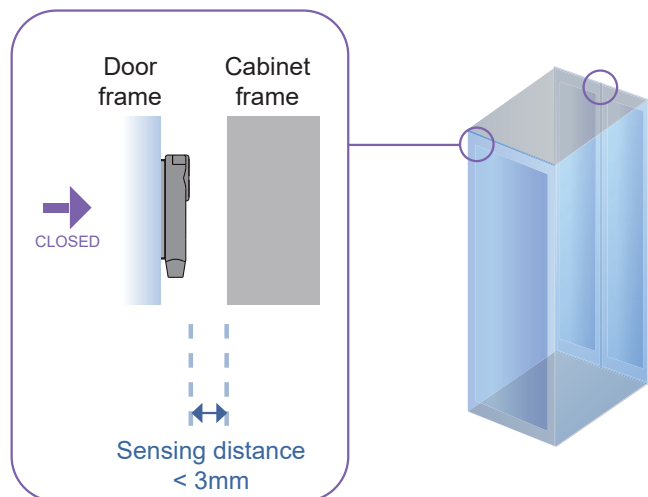

DOOR OPEN

- open door
- inductive sensor lose detection with cabinet frame
- Red LED of sensor light up
- DOOR OPEN SIGNAL sends out

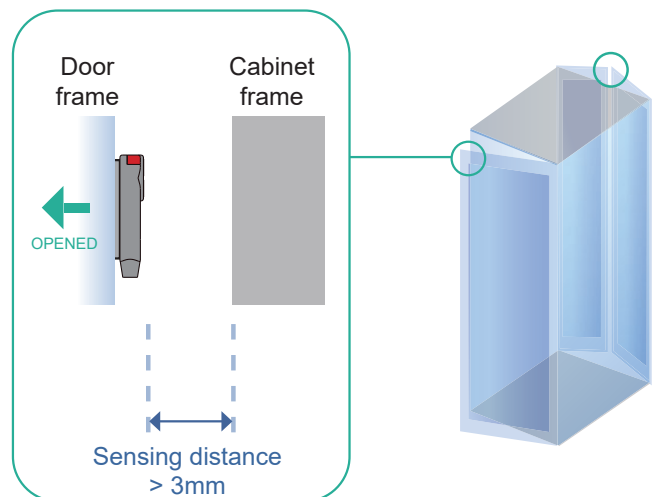

< 1.4 > Door Sensor Installation **IR Sensor**

IR Door Sensor, pair (S-DIR)

Features

- Magnetic base for easy setup
- No custom cutting required on doors
- Light weight & mini size (33 x 19 x 7 mm)
- 2m cord



Requirement

- rack frame made of ferrous metal (iron)
- sensing distance
- door close : < 40mm
- door open : > 50mm

Package content

- IR sensor w/ 2m cable x 2
- reflective label x 2 (opposite to the IR door sensor for a better response, size: 30 x 40 mm)

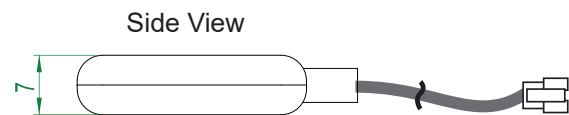
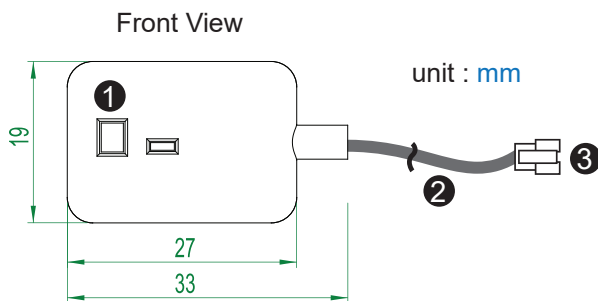

①	Sensor area
②	2m cable
③	Cable jack (connect to handle)

Installation steps

- connect to the handle
 - guide & fix the cable with cable clips (bundle with handle package)
 - place the sensor at the top of the door, close to the hinge side
 - adjust the sensor to ensure the sensing distance between door to frame within 5mm while door in close status
 - stick the reflective label on the rack frame just opposite to the sensor position
- door close : < 40mm
 door open : > 50mm

Suggested sensor position

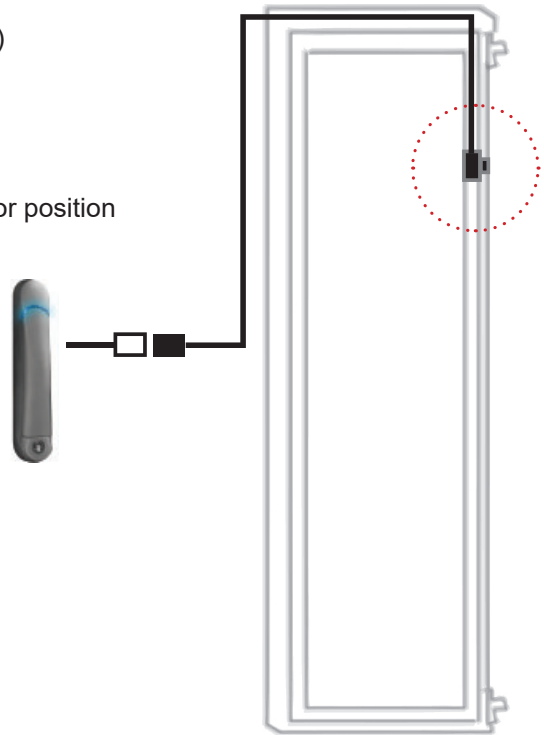

Sensor Operation

DOOR CLOSE

- close door
- IR sensor detects the rack frame
- DOOR CLOSE SIGNAL sends out

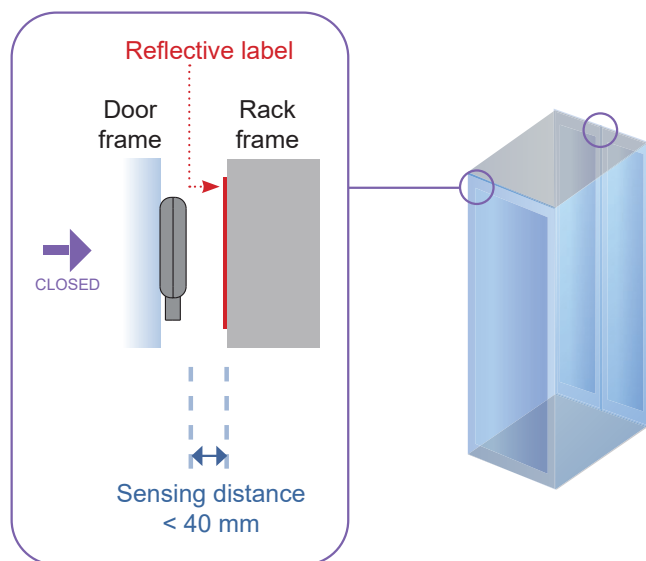

DOOR OPEN

- open door
- IR sensor lose detection with rack frame
- DOOR OPEN SIGNAL sends out

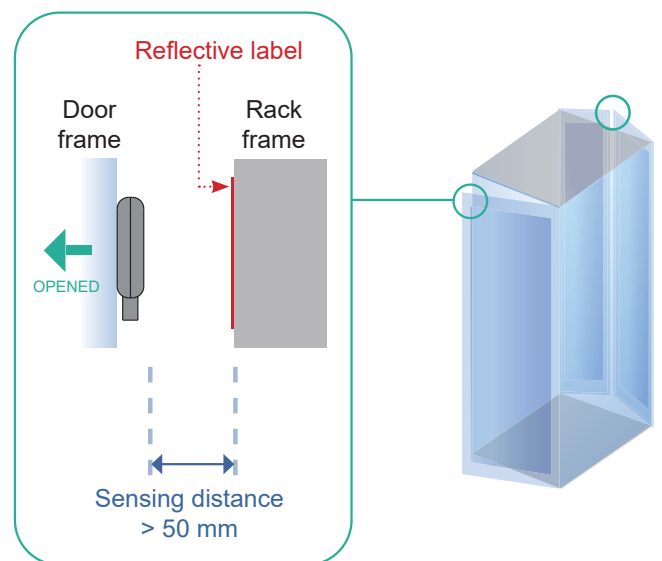

-  sensing distance
 door close : < 40mm
 door open : > 50mm

< 1.4 > Door Sensor Installation Mechanical Sensor

Mechanical Door Sensor, pair (S-DSW)

- Low cost / precise
- Size (36.3 x 15 x 30.75 mm)
- 2m cord

Package content

- Mechanical sensor w/ 2m cable x 2
- Mounting bracket x 2

Top View

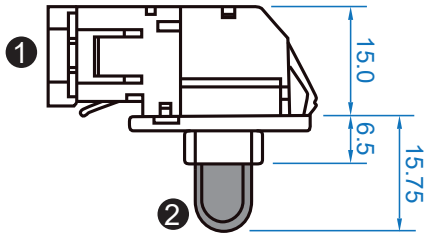

Front View

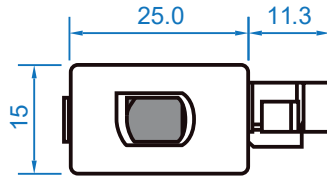

Side View

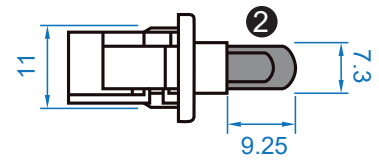

unit : mm

①	Cable connector
②	Press button (total travel distance : 9.25 mm) (min. actuation distance : 3.00 mm)

Mounting by custom cutout on door frame

- Cutout size (23 x 12.5 mm)

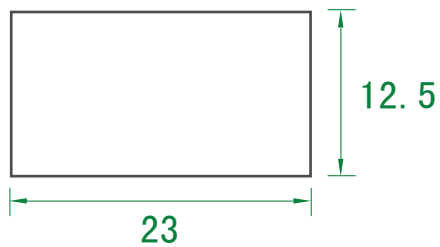

Mounting by bundled bracket

- Ø6.5mm hole cutting required on door frame

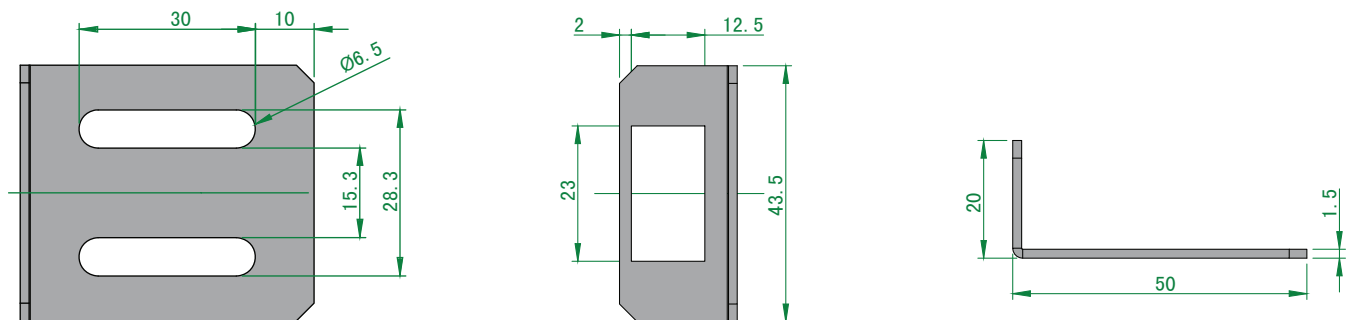

unit : mm

Installation steps

- connect to the handle
- place the sensor at the top middle of the door
- secure it with mounting screws x 2

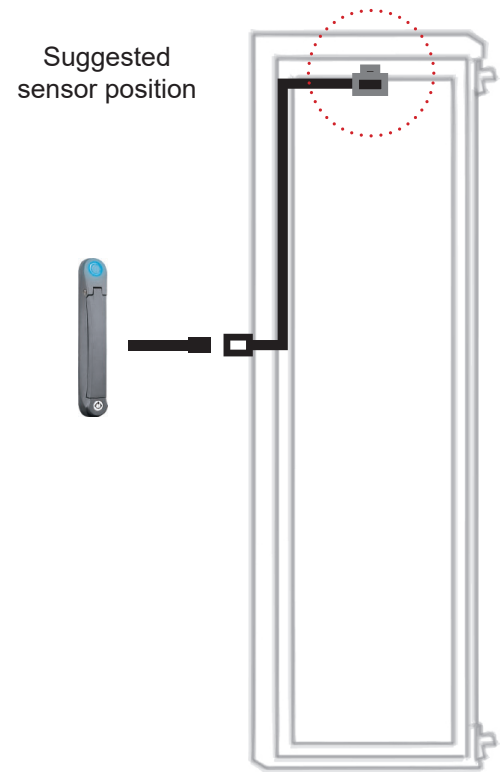

Sensor Operation

DOOR CLOSE

- close door
- Sensor button is pressed on
- DOOR CLOSE SIGNAL sends out

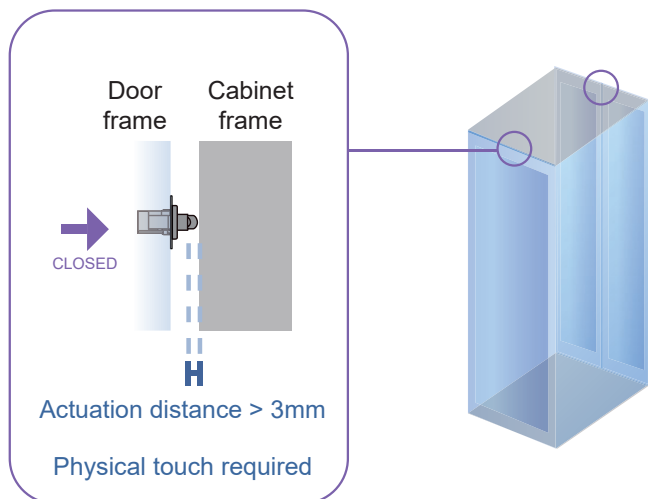

DOOR OPEN

- open door
- Sensor button is released
- DOOR OPEN SIGNAL sends out

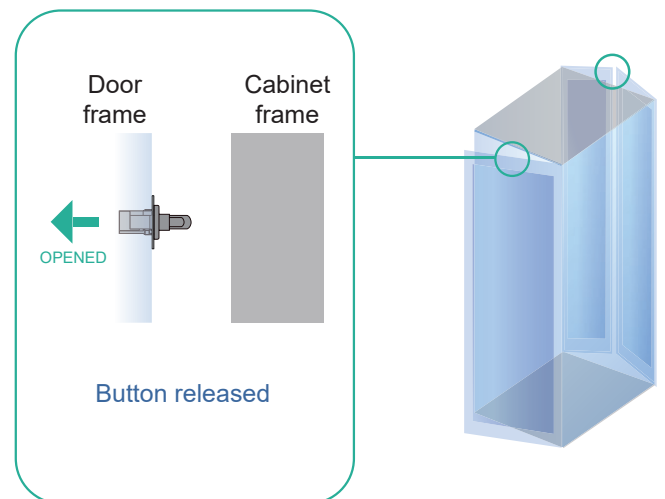

< Part 2 > Handle Usage & Operation
 < 2.1 > Two Important Notes

Important Note for Key lock

- ⚠ Under Smartcard mode, always keep key cylinder to 12 o'clock direction.

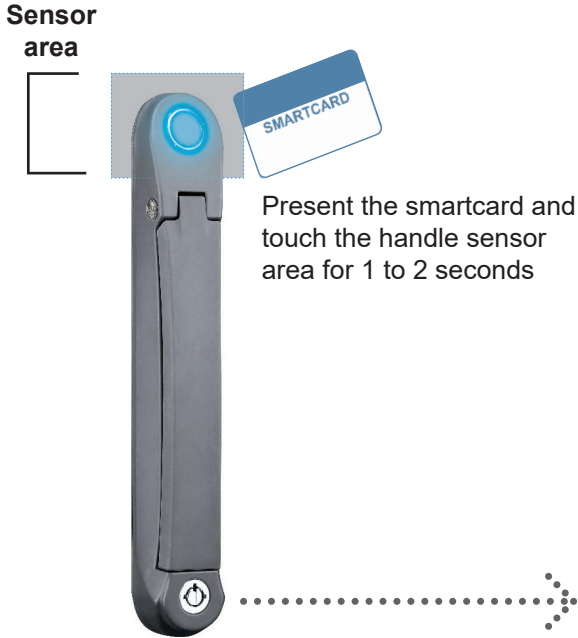

✗	← 	Key lock mode Key cylinder to 9 o'clock direction Under key lock mode, even present the smartcard, the handle still keeps locked.
✗	→ 	Key unlock mode Key cylinder to 3 o'clock direction Under key unlock mode, the handle keeps unlocked.
✓		Smartcard mode ⚠ For smartcard operation, keep key cylinder always to 12 o'clock direction .

- ⚠ Unless the smartcard handle is defective, lock / unlock the handle by key is NOT recommended
- Please insert & turn the key with push force



	← 	Key lock mode Key cylinder to 9 o'clock direction.
	→ 	Key unlock mode Key cylinder to 3 o'clock direction.

Maintenance Key (MK-001)

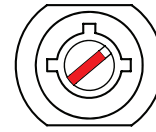

- Improper key usage may cause the cylinder stuck at abnormal direction 1 to 2 o' clock.
- Under this circumstance, the **maintenance key (MK-001)** is required to solve the problem.
- Please insert the **maintenance key** to the cylinder with push force for turning it to normal direction 9 or 12 or 3 o'clock.



Important Note for Handle

For your own safety, please return the handle to park position properly in case reckless collision.



< 2.2 > Handle Operation with Door Sensor

✓ How to unlock the handle & open the door properly

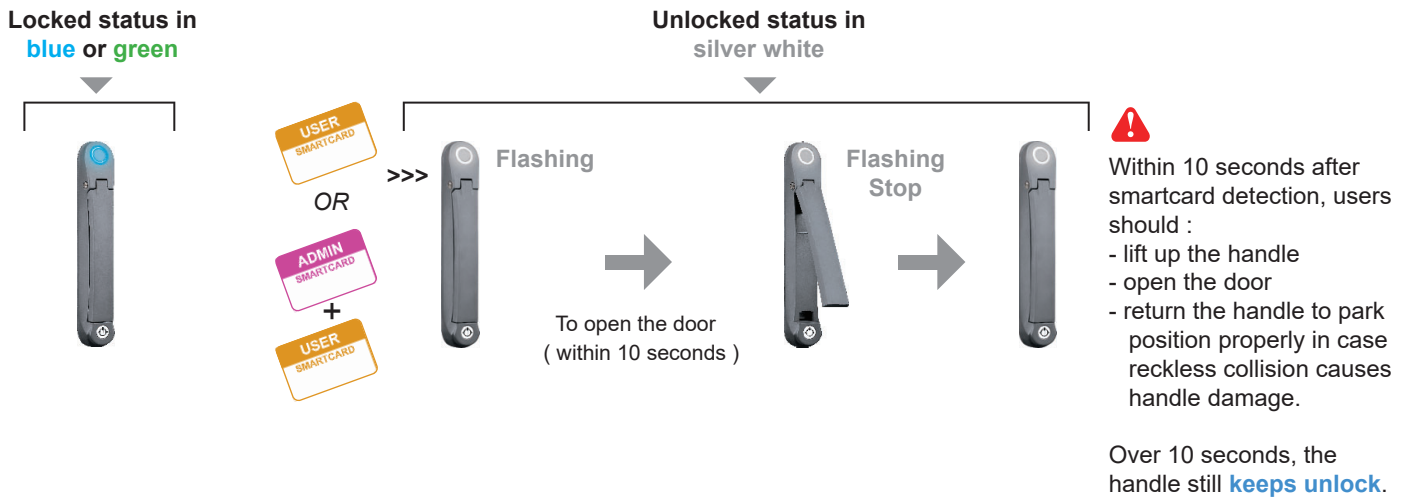

✗ Unlock the handle but NOT open the door

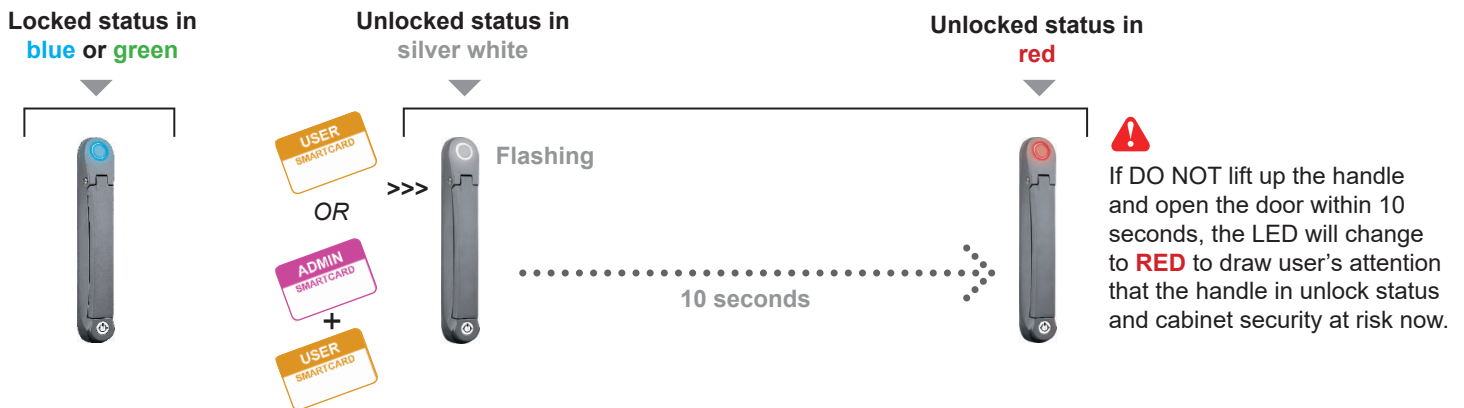

✗ Unauthorized door-open

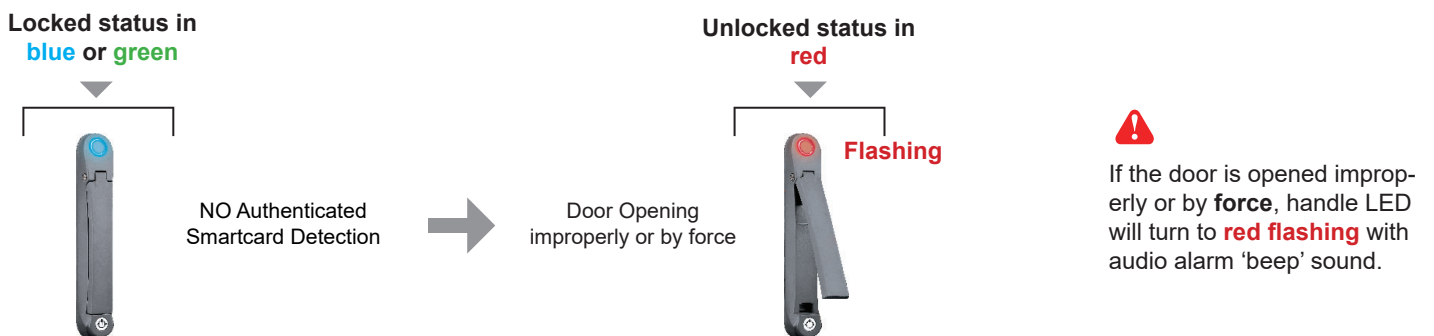



How to close the door properly

Unlocked status in
silver white

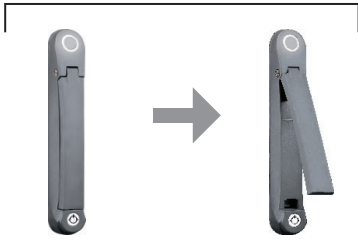

To close the door

Locked status in
blue or green



- Users should :
- lift up the handle
 - close the door
 - return the handle to park position properly
 - the handle will **auto-lock**

< 2.3 > Handle Operation without Door Sensor

✓ How to unlock the handle & open the door properly

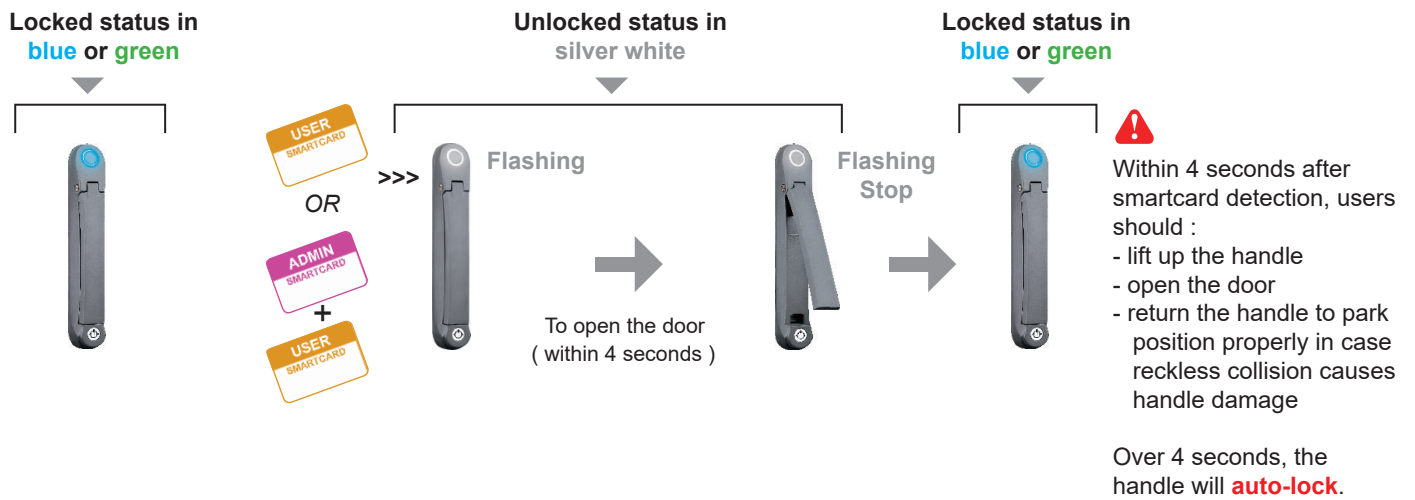

✗ Unlock the handle but NOT open the door

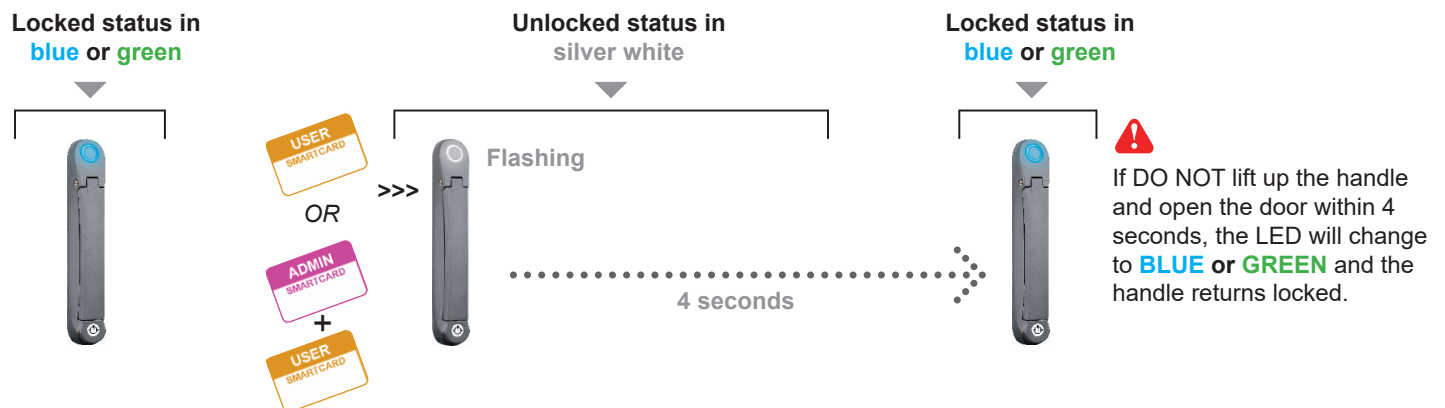

✗ Unauthorized door-open



✓ How to close the door properly

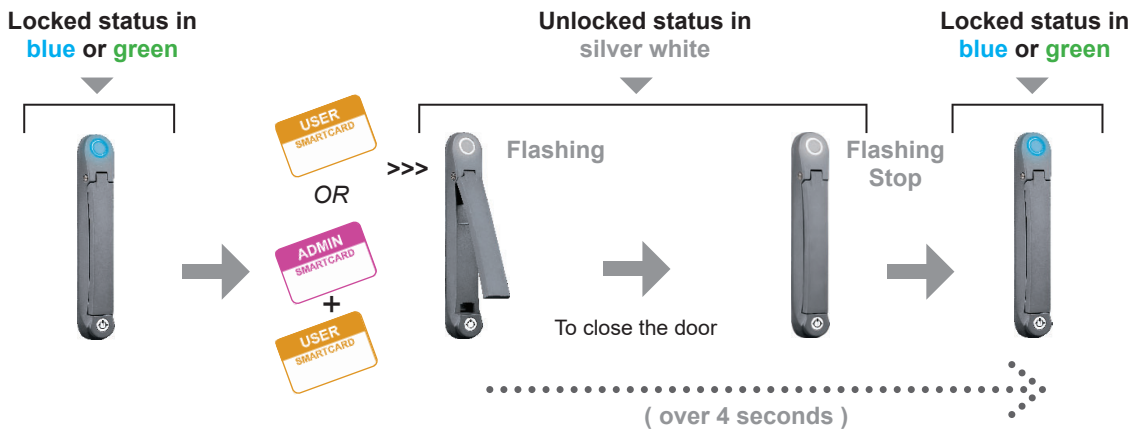

- ⚠ After smartcard detection, users should :
- 1) lift up the handle
 - 2) close the door
 - 3) over 4 seconds, the handle will **auto-lock**, then return the handle to park position properly

IMPORTANT NOTE :

User **MUST** follow the step no.3, otherwise, the handle locking will fail.

< Part 3 > Hardware Specifications

< 3.1 > S800

Item	Power	100~240VAC, 50 / 60Hz 0.5A via AC / DC cord
	Regulation Approval	FCC, CE
Environmental	Operation	0° to 50°C Degree
	Storage	-5° to 60 °C Degree
	Relative Humidity	90%, non-condensing
	Shock	50G peak acceleration (11 ms, half-sine wave)
	Vibration	58~100Hz / 0.98G (11ms / cycle)
Packing	Gross Weight	1.82 kg / 4.0 lb
	Carton size (W x L x H)	310 x 310 x 95 mm 12.2 x 12.2 x 3.7 inch
Safety Regulatory	FCC & CE certified	
Environmental	RoHS3 & REACH compliant	

< Part 4 > Software Download

< 4.1 > Software Features & Hardware Requirements

Software Features

	Utilities ISU-01
Max. 500 pairs of handle	
Max. 50 user card authentication per handle	✓
Dual or single card mode authentication**	✓
Enable or disable door sensor detection**	✓
Detailed user card information	
Reporting on configuration details	
Log in password	

** Optional feature

Hardware Requirements

Please prepare a notebook computer with the hardware specifications as below for InfraSolution S Utilities ISU-01.

Recommended hardware :

- Processor: Dual Core 2GHz or above
- Memory: 2GB RAM
- Available Disk Space: 2GB
- Display: 1024 x 768 or higher resolution



USB port x 1 required for the data input cable & smartcard handle configuration

< 4.2 > Supported OS Platform & Language

Supported OS platform & language list :

- MS Windows XP Professional with SP3 (32bit, English edition only)
- MS Windows 7 Professional with SP1 (32bit & 64bit, English edition only)
- MS Windows 8 Professional (32bit & 64bit, English edition only)

User can select the following languages under Control Panel > Region and Language in English Edition OS:

- 1) Arabic (Saudi Arabia)
- 2) Chinese (Traditional, Hong Kong S.A.R.)
- 3) Dutch (Netherlands)
- 4) English (Australia)
- 5) English (United Kingdom)
- 6) English (United States)
- 7) French (France)
- 8) German (Germany)
- 9) German (Switzerland)
- 10) Italian (Italy)
- 11) Japanese (Japan)
- 12) Korean (Korea)
- 13) Norwegian (Norway)
- 14) Portuguese (Portugal)
- 15) Russian (Russia)
- 16) Spanish (Spain)
- 17) Turkish (Turkey)

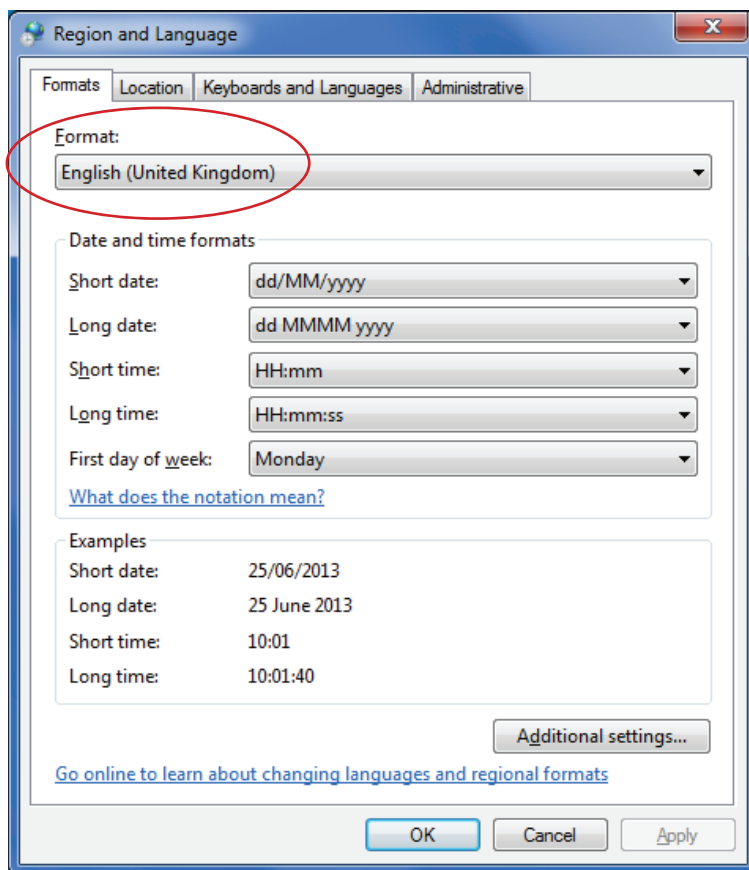

< 4.3 > Utilities ISU-01 Download & Installation

After the handle installation, please take the following steps to install the utilities :

1. Prepare a notebook computer to download the handle setup utilities from the link :
<http://www.austin-hughes.com/support/utilities/infrasolutionS/ISU-01.msi>

2. Double click the ISU-01.msi and follow the instruction to complete the installation.

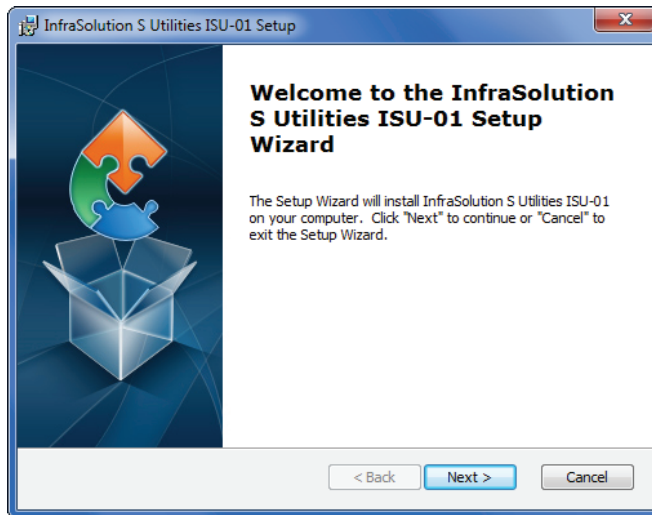

↓
click “ **Next** ”

↓
click “ **Install** ”

↓
click “ **Finish** ”

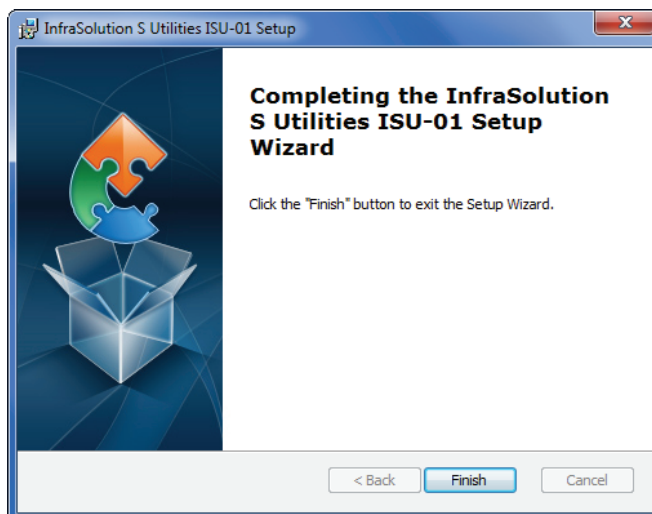

..... **Complete**

< 4.4 > Driver Installation for Data Input Cable

Before initial configuration for handles, user **MUST** install the driver for the data input cable **ONCE**. Please follow 13 steps below to complete the installation.

Step 1.

Connect the handle to the notebook computer via the handle data input cable (ISW-USB-1.8).

 Make sure the handle in power ON status

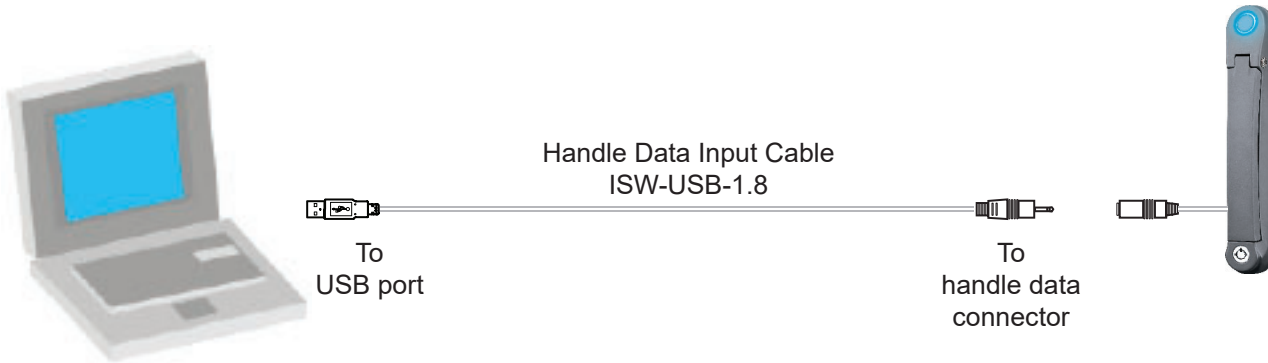

 If the notebook is MAC model, users may need to download the USB driver to run Windows OS under MAC notebook PC.

<http://www.austin-hughes.com/support/utilities/infrasolutionS/ISW-USBV20828-32bit.7z>

OR

<http://www.austin-hughes.com/support/utilities/infrasolutionS/ISW-USBV20828-64bit.7z>

Step 2.

Right click “ **My computer** ” & Select “ **Manage** “. Click “ **Device Manager** “. Then user can see an improper USB UART driver installed under “ **Other devices** ” .

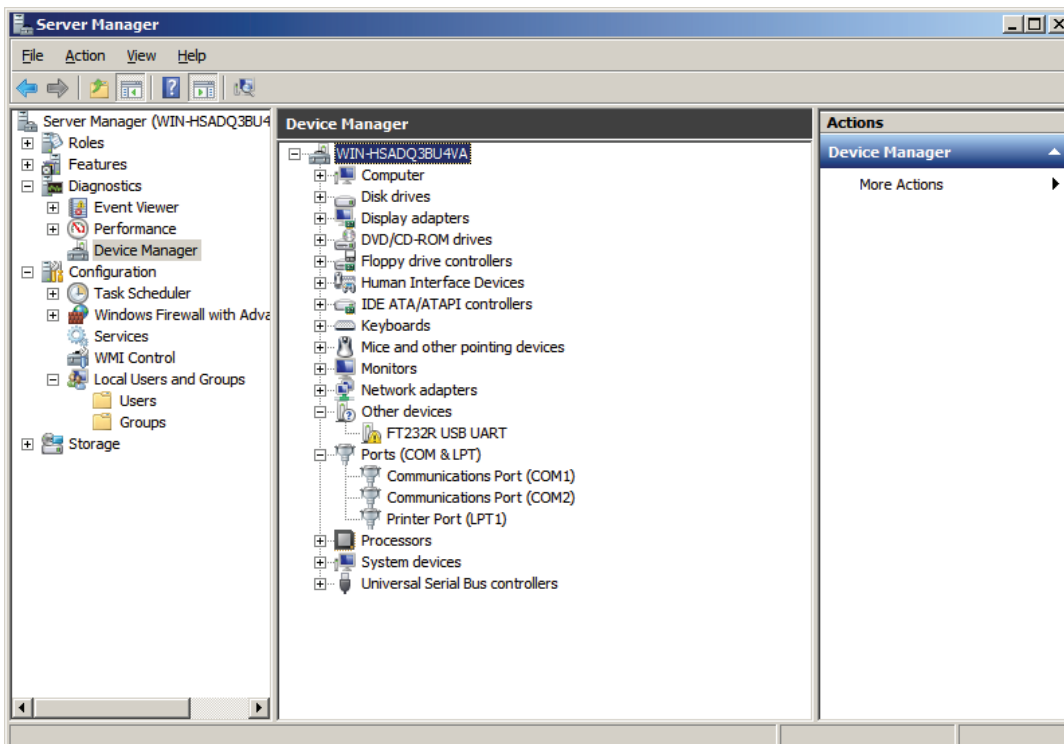

Step 3.

Right Click the improper installed **USB UART** driver & Select “ **Update Driver Software...** ”.

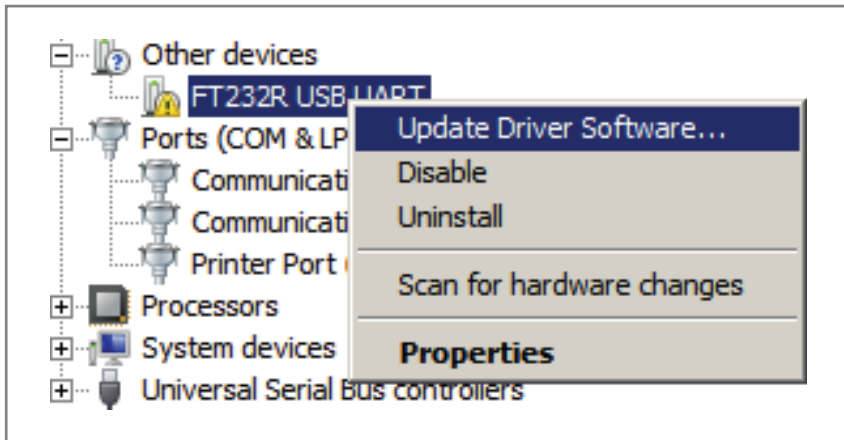

Step 4.

A window pops up & please Select “ **Browse my computer for driver software** ”.

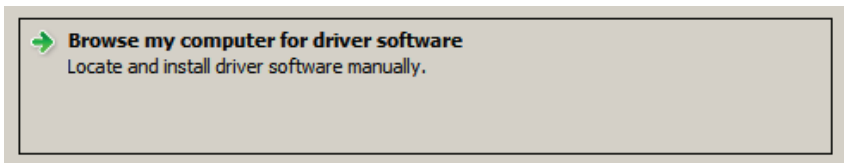

Step 5.

Click “ **Browse** ” to search the path of the driver software.

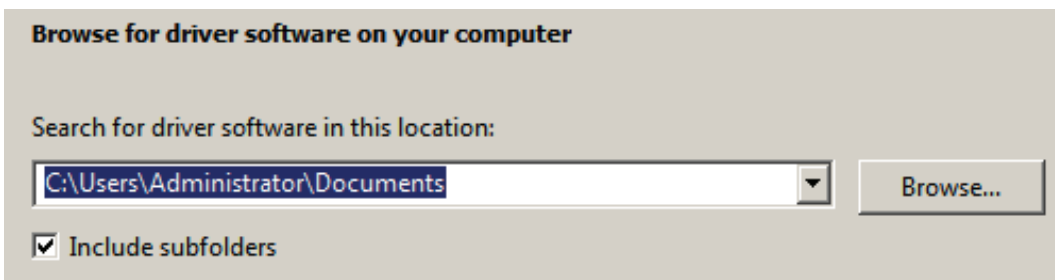

< 4.4 > Driver Installation for Data Input Cable

Step 6.

Select **C:\ > Program Files > InfraSolution S – Setup Utilities > Driver** & Click “**OK**”

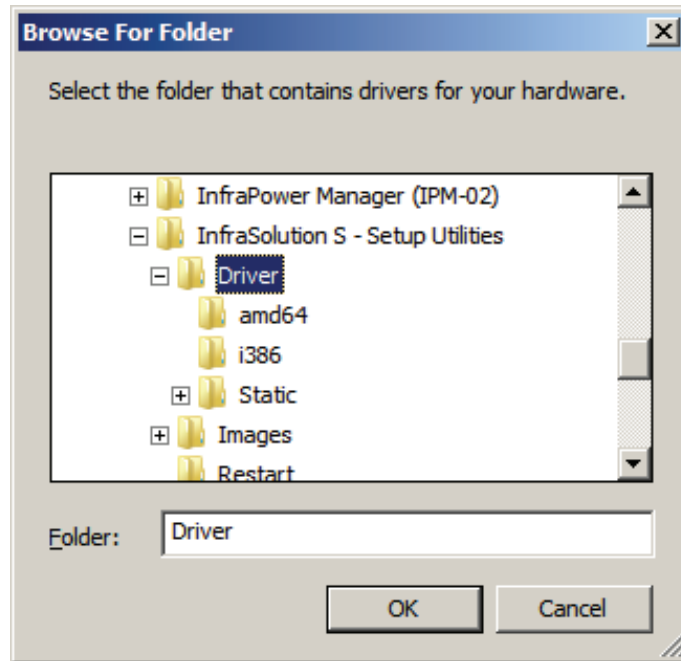

Step 7.

Click “**Next**” to install the driver.



Step 8.

It takes a few seconds to complete. When complete, Click “**Close**”



Step 9.

“**USB Serial Converter**” shows under “**Universal Serial Bus controllers**”.

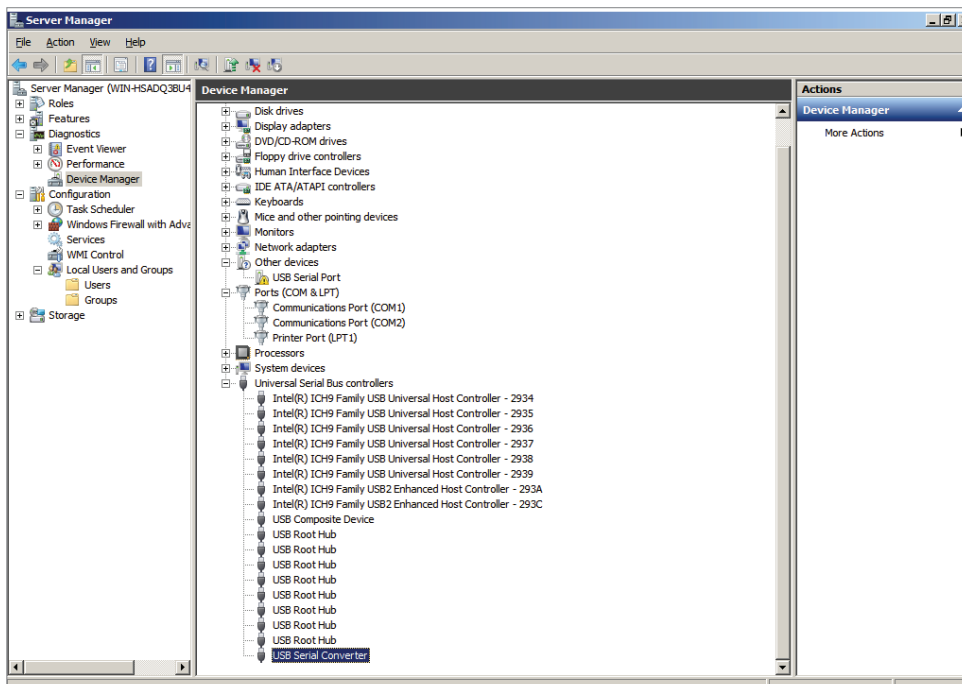

Step 10.

Right Click “ **USB Serial Port** “ under “ **Other devices** “ & Select “ **Update Driver Software...** ”.

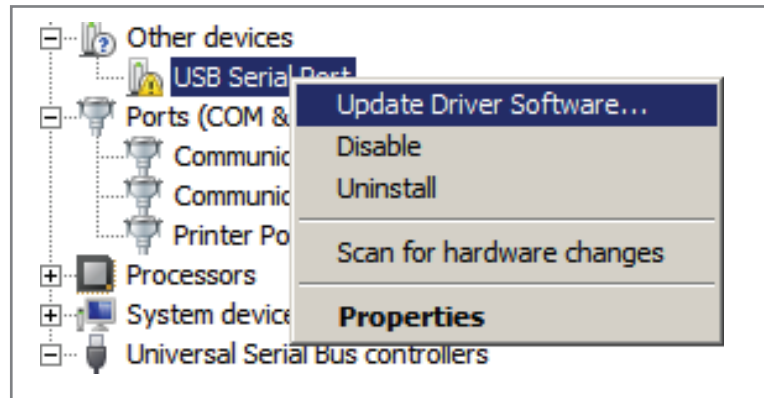

Step 11.

Select “ **Browse my computer for driver software** “.

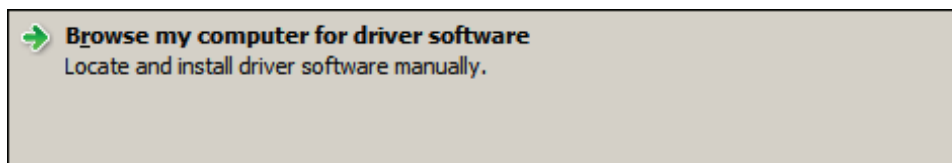

Step 12.

Click “ **Browse** “ to search the correct path of the driver software & Click “ **Next** “ to install the driver.

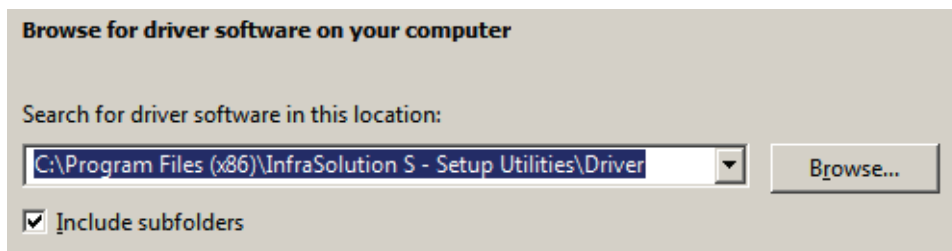

Step 13.

It takes a few seconds to complete. When complete, Click “ **Close** ”

..... **Complete**

< Part 5 > Software Usage

< 5.1 > Initial Handle Configuration

After hardware & software installation, please take the following steps to configure the handle.

- (1) Prepare the notebook computer installed with utilities ISU-01
- (2) Connect to the handle via the handle data input cable (ISW-USB-1.8)
- (3) Make sure the handle in power ON status
- (4) Configure the handle according to the UI
- (5) After finish the handle configuration, please repeat the steps for other handles **One by One**

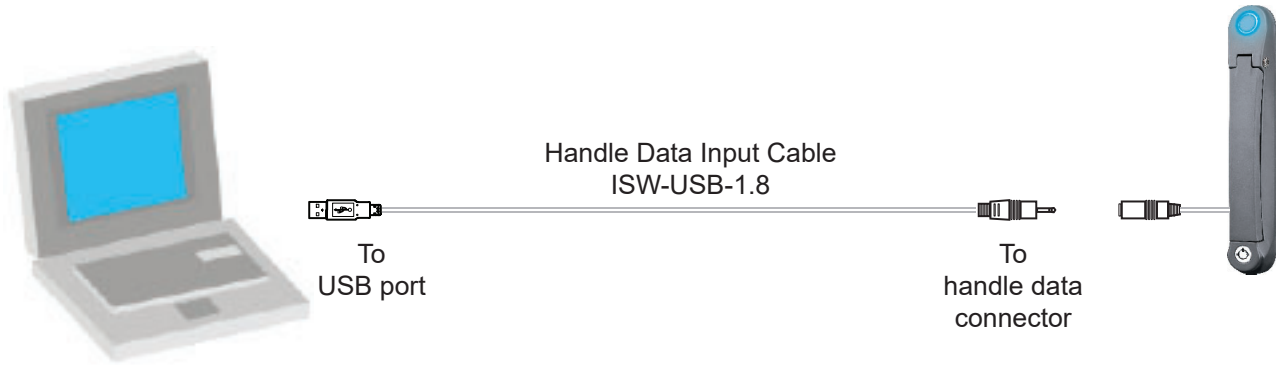

If the OS platform of the notebook computer is **MS Windows 7**, please take the following steps :

- Right Click **InfraSolution S Utilities ISU-01** , and then Select “ **Properties** ” .
- Click the “ **Compatibility** ” tab.
- Tick the box “ **Run this program as an administrator** ” , and then Click “ **OK** ” .

If don't take the above steps, the UI will not display properly.

InfraSolution S Utilities ISU-01 Version: Q213V1

Handle Information

Handle ID: 243131279-8PD001
 Model no.: S-800P
 Type: Proximity
 Last updated: 2013 / 04 / 18 12:22

Handle Location

Zone:
 Rack:
 Handle position: Front Rear

Door Sensor

Disable Enable
Ensure you have ordered door sensors and finished the installation and connection. Otherwise, DO NOT enable door sensor as it will cause malfunction.

Card Access Mode

Normal (User card only)
 Dual Card Authentication (Administrator card + User card)

Apply Cancel Export Import

Status:

Card Assignment (Max. 50)

1	00105208	26
2		27
3		28
4		29
5		30
6		31
7		32
8		33
9		34
10		35
11		36
12		37
13		38
14		39
15		40
16		41
17		42
18		43
19		44
20		45
21		46
22		47
23		48
24		49
25		50

Card Edit Delete

Handle Information

In < **Handle Information** >, shows the handle ID #, model, card type & the time of last configuration.

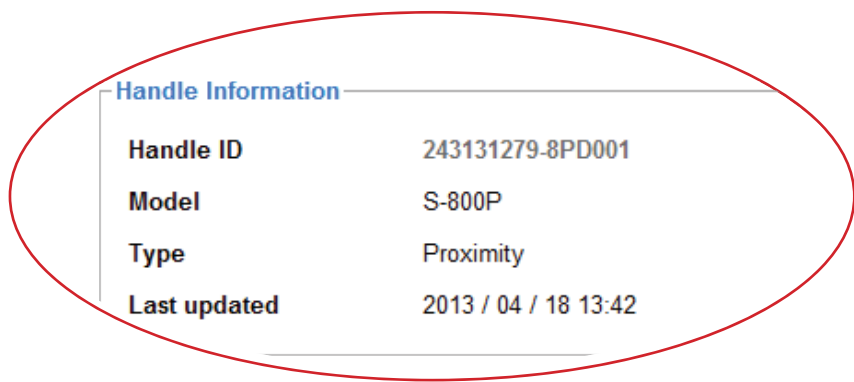

< 5.1 > Initial Handle Configuration

Handle Location

In < **Handle Location** >, record the **Zone**, **Rack** and **Handle position** of the handle.

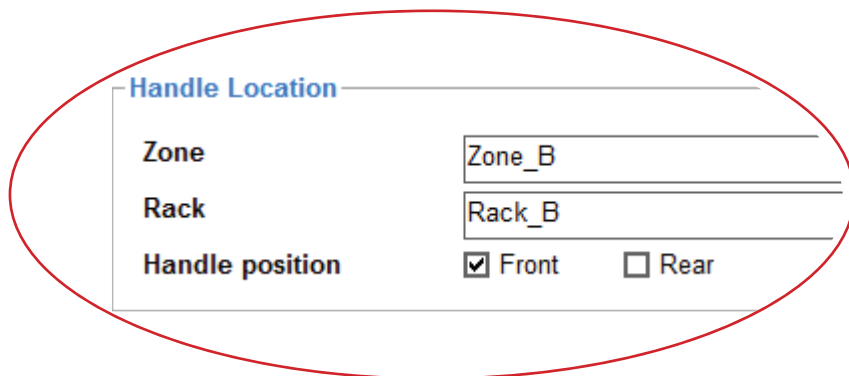

Handle Location	
Zone	Zone_B
Rack	Rack_B
Handle position	<input checked="" type="checkbox"/> Front <input type="checkbox"/> Rear

Door Sensor (Option)

In < **Door Sensor** >, enable or disable the door sensor. Default is " Disable ".

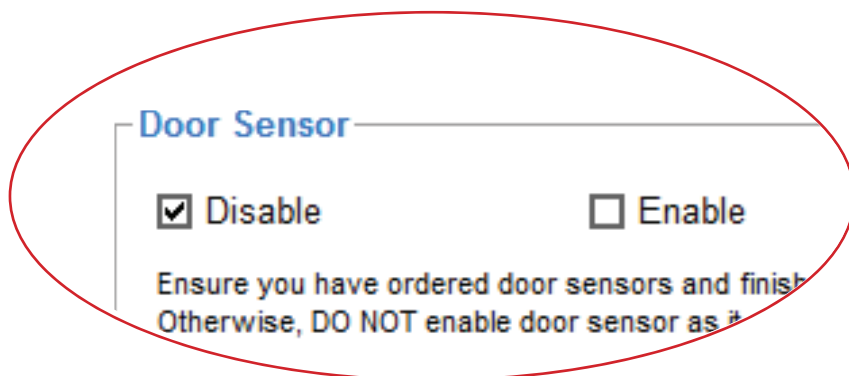

Door Sensor	
<input checked="" type="checkbox"/> Disable	<input type="checkbox"/> Enable
Ensure you have ordered door sensors and finished the installation. Otherwise, DO NOT enable door sensor as it will cause malfunction.	



Ensure you have ordered door sensors and finished the installation. Otherwise, DO NOT enable door sensor as it will cause malfunction.

Card Access Mode (Option)

In < **Card Access Mode** >, select the handle to run as **Normal** **OR** **Dual Card Authentication** mode.

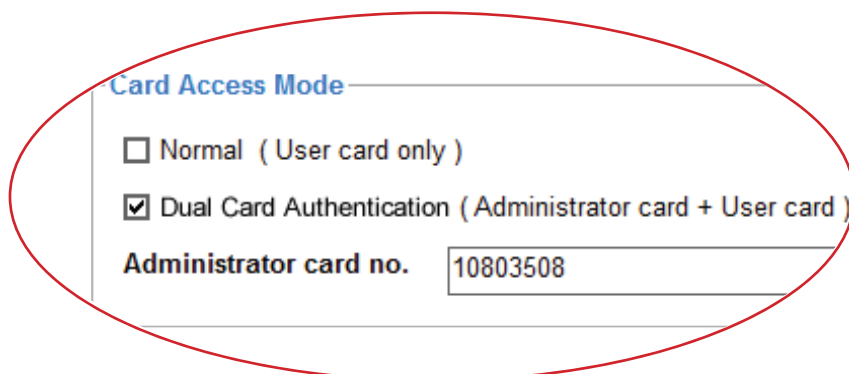

Card Access Mode	
<input type="checkbox"/> Normal (User card only)	<input checked="" type="checkbox"/> Dual Card Authentication (Administrator card + User card)
Administrator card no.	10803508



- If select **Dual Card Authentication**, please input Administrator card no. .
- Only ONE admin. card for each handle.
- User **MUST** order Dual card authentication option before delivery.
- While unlock the handle and open the door under Dual card authentication mode, present the admin. card first, then user card within 10 seconds.

< 5.2 > Card Assignment

In < **Card Assignment** >, assign, edit or delete user card.

The screenshot shows a web interface for card assignment. At the top, there's a title "Card Assignment (Max. 50)" and two buttons: "Card Edit" and "Delete". Below this is a table with 33 rows. The first six rows have card numbers: 00105208, 10800074, 00026156, 00104507, 00104531, and an empty field. The remaining rows are empty. The table is circled in red.

Card Assignment (Max. 50)		Card Edit	Delete
1	00105208	26	
2	10800074	27	
3	00026156	28	
4	00104507	29	
5	00104531	30	
6		31	
		32	
		33	

Card Assignment by two methods

- (1) Click **Card Edit**, then direct input the last 8 digits of the card number to the field
- (2) Click **Card Edit**, then present the smartcard to the handle and the last 8 digits of the card number will be input to the field simultaneously & automatically

Card no. Change

- (1) Click **Card Edit**, then change the existing card numbers in the field

Card Delete

- (1) Click **Card Edit**, then delete the card number in the field one by one

All Card Delete

- (1) Click **Delete**, then confirm this command and all card assignment will be deleted



Click "**Apply**" to finish the above configuration for smartcard.

< Part 6 > Software Usage

< 6.1 > Export & Import Handle Configuration

In < **Export** > and < **Import** >, provide a quick way to configure other handles with same or similar configuration on < **Card Assignment** >, < **Door Sensor** >, < **Card Access Mode** >.

Steps for **Export** :

- (1) Click “ **Export** ” and Click “ **Yes** ” from the pop up window
- (2) Provide the name and path of the export file and follow the instruction to complete the export

The screenshot displays the 'InfraSolution S Utilities ISU-01' window. It is divided into several sections for configuring a handle:

- Handle Information:** A table showing details for handle ID 243131279-8PD001, model S-800P, type Proximity, and last updated on 2013/04/18 at 13:42.
- Handle Location:** Fields for 'Zone' (Zone_B) and 'Rack' (Rack_B). 'Handle position' is set to 'Front' with a checked checkbox, and 'Rear' is unchecked.
- Door Sensor:** 'Disable' is selected with a checked checkbox, and 'Enable' is unchecked. A note below states: 'Ensure you have ordered door sensors and finished the installation and connection. Otherwise, DO NOT enable door sensor as it will cause malfunction.'
- Card Access Mode:** 'Dual Card Authentication (Administrator card + User card)' is selected with a checked checkbox. The 'Administrator card no.' field contains the value 10803508.

At the bottom, there are four buttons: 'Apply', 'Cancel', 'Export', and 'Import'. The 'Export' button is circled in red. Below the buttons, a status bar reads: 'Status: Synchronizing data with handle [243131279-8PD001].....100%'.

Steps for **Import** :

- (1) Select the handle which you want to import handle configuration file
- (2) Connect the handle to the notebook computer via the handle data input cable (ISW-USB-1.8)
- (3) Click “ **Import** “ and Click “ **Yes** “ from the pop up window
- (4) Select the file to import & follow the instruction to complete the import step
- (5) After import completed, edit the field (s) on **Zone** , **Rack** if necessary
- (6) Click “ **Apply** “ to finish file import

The screenshot displays the 'InfraSolution S Utilities ISU-01' application window. It features several sections for configuring a handle:

- Handle Information:** A table showing Handle ID (243131279-8PD001), Model (S-800P), Type (Proximity), and Last updated (2013 / 04 / 18 13:42).
- Handle Location:** Fields for Zone (Zone_B) and Rack (Rack_B), and a Handle position section with 'Front' checked and 'Rear' unchecked.
- Door Sensor:** 'Disable' is checked, and 'Enable' is unchecked. A note below states: 'Ensure you have ordered door sensors and finished the installation and connection. Otherwise, DO NOT enable door sensor as it will cause malfunction.'
- Card Access Mode:** 'Dual Card Authentication (Administrator card + User card)' is checked, and 'Normal (User card only)' is unchecked. The Administrator card no. is 10803508.

At the bottom, there are four buttons: 'Apply', 'Cancel', 'Export', and 'Import'. The 'Import' button is circled in red. Below the buttons, the status bar reads: 'Status: Synchronizing data with handle [243131279-8PD001] 100%'.

Utilities – ISU-01

1. What is Utilities – ISU-01 ?

- ISU-01 is a Windows based utility to provide a simple & user friendly way for initial handle setup

2. Which OS platform does ISU-01 support ?

- MS Windows XP Professional with SP3 (32bit, English edition only)
- MS Windows 7 Professional with SP1 (32bit & 64bit, English edition only)
- MS Windows 8 Professional (32bit & 64bit, English edition only)

3. Why the handle ID no. NOT show in UI ?

- ensure the handle is in power ON status
- ensure the driver installation for data input cable (ISW-USB-1.8) completed

4. How to do if lost the user card ?

- open the door by key and edit the card assignment

5. Why can't select " Dual card authentication " in ISU-01 ?

- ensure you have ordered this option before delivery
- if this option required after handle installation, you need to order a new handle with this option & replace the existing one

Smartcard Handle

1. How many user card can I assign to each handle ?

- up to 50

2. How many Administrator card can I assign to each handle ?

- one

3. Why does the LED light change to RED after I present a valid user card without open the door ?

- remind you the cabinet security at risk now because the handle in unlock status but the door not open yet

4. Why can't open the door even I presented a valid user card to the handle ?

- ensure the handle lock under the smartcard mode that key cylinder at 12 o'clock direction. Please refer user manual " Part II < 2.1 > Two Important Notes " .

Others

1. Where can I get the USB driver for the data input cable (ISW-USB-1.8) ?

- for 32 bit OS : <http://www.austin-hughes.com/support/utilities/infrasolutionS/ISW-USBV20828-32bit.7z>
- for 64 bit OS : <http://www.austin-hughes.com/support/utilities/infrasolutionS/ISW-USBV20828-64bit.7z>

2. Where can find the Catalog / User manual / Model list of Cabinet Smart Card Handle ?

- please visit www.austin-hughes.com

3. How can get further support ?

- please send email to support@austin-hughes.com or sales@austin-hughes.com

< Part 8 > Troubleshooting

1. Handle ID no. not shown in UI

Step 1 - Handle is OFF ?

ensure the handle is in power ON status

Step 2 - Check the driver of the data input cable installed properly ?

ensure the driver is installed properly. Please refer to user manual “ Part IV < 4.4 > Driver installation for Data Input Cable “

Step 3 - Check the USB port of the notebook computer ?

Try to plug the data input cable into another USB port of the notebook computer.

Step 4 - Data input cable defective ?

Replace another data input cable.

2. Handle can't be locked after closed the door

Step 1 - Check door sensor is installed ?

If NO door sensor is installed, please select disable in < Door sensor > in ISU-01.

Otherwise, the handle CANNOT be locked after you unlock it.

Step 2 - Door sensor sensing distance when door close greater than 3mm (Inductive sensor only) ?

Ensure the distance between the door sensor and cabinet frame is LESS than 3 mm. Please refer to user manual “ Part I < 1.4 > Door Sensor Installation ”

Step 3 - Handle lock under key unlock mode and key cylinder at 3 o'clock direction ?

Ensure the handle lock under the smartcard mode that key cylinder at 12 o'clock. Please refer to user manual “ Part II < 2.1 > Two Important Notes “

< Part 9 > Optional Accessories

Inductive door sensor, pair (S-DSI)

- Light weight, mini size & adhesive
- No custom cutting required on doors
- Easy for existing cabinet retrofit or integration to new cabinet

IR door sensor, pair (S-DIR)

- Magnetic base for easy setup
- No custom cutting required on doors
- Light weight & mini size (33 x 19 x 7 mm)
-

Mechanical door sensor, pair (S-DSW)

- Low cost
- Precise
- Cost efficient integration to new cabinet
- Custom cutting required on doors

Handle data input cable, pc (ISW-USB-1.8)

- Connect the smartcard handle to the laptop for handle activation, data input & configuration

Individual key lock, set of two for front & rear door (ISK-C051)

- Up to 500 individual key-locks available

Unique key lock (ISK-UKL)

- Unique key dedicated to single project / customer regionally
- For project size over 500 cabinets

Dual card authentication (DCS-01)

- Software upgrade for additional security
- Cabinet access by administrator card + user card

** Order this option before the delivery

Proximity smartcard, pack of 10 (ISC-P10)

- Proximity 26-bit format
- Single card for multiple application
- Custom card layout available

MiFARE smartcard, pack of 10 (ISC-M10)

- MiFARE 26-bit format
- Single card for multiple application
- Custom card layout available

Proximity card reader (ISC-PCR)

- Proximity 26-bit smartcard compatible
- Convenient way for smartcard ID reading
- Driverless for easy installation

MiFARE card reader (ISC-MCR)

- MiFARE 26-bit smartcard compatible
- Convenient way for smartcard ID reading
- Driverless for easy installation

Intentionally Left Blank

The company reserves the right to modify product specifications without prior notice and assumes no responsibility for any error which may appear in this publication.

All brand names, logo and registered trademarks are properties of their respective owners.

Copyright 2020 Austin Hughes Electronics Ltd. All rights reserved.

UM-ISU-S800-Q420V1

www.austin-hughes.com