

4K UHD

UltraView

Professional and Versatile LED Monitor

UltraView 4K LED monitor series supports 3840 x 2160@60Hz resolution, 4 times the resolution of FHD. 1.07 billion / 16.7 million colors achieve optimal picture quality. Reduced energy and fan-less architecture provides professional-use durability and around-the-clock operation.

K23"

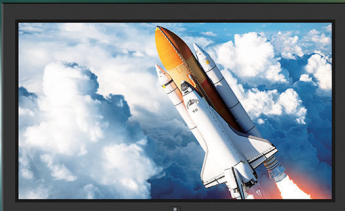

K17"



K15"



K13"



UltraView 4K professional LED is more than just a standalone monitor. UltraView has a variety of embedded modules including HDMI Decoder, HDMI Extender, Multi-Monitor OSD Controller, 3G & 12G SDI Input. The embedded modules give you the ability of video remote management and transmission for multiple monitors over network.

As a versatile 4K monitor, UltraView 4K professional LED is meticulously designed to meet professional and environmental demands including Front Protection, Anti-reflective/Vandal proof glass, DC power input, Brightness dimming and Mounting kit for Overhead tilted wall-mount, Panel-mount, VESA-mount, Universal-mount and Desktop stand.

With over 25 years' production experience, the UltraView structure is well-engineered and manufactured by our own CNC facilities and team of experts to ensure its ruggedness, mobility and quality, as well as being suitable for harsh environment applications. The structure can be customized if required to facilitate monitor installation. Our knowledgeable engineers are able to provide frame customization for specific dimensions, color, metal treatment, screen printing, bezel and mounting.

Product Highlights



Key Benefits

- ▶ 3840 x 2160@60Hz native UHD resolution
- ▶ 1920 x 1080 & 1920 x 1200 resolution support
- ▶ K23": 1.07 billion colors (10-bit)
- ▶ K17", K15" & K13": 16.7 million colors (8-bit)
- ▶ PIP Sub-screen & PBP Dual-screen viewing efficiency
- ▶ Display port 1.2 + HDMI 1.4 + HDMI 2.0 video input
- ▶ Video decoding capability up to 1080p (option)
- ▶ Rugged structure ensures high mobility
- ▶ IP65 front protection (NAP series)
- ▶ Professional-use durability & around-the-clock operation
- ▶ 2-year standard warranty (upgradable up to 5 years)

Applications

- Broadcasting / Advertising
- Traffic control / Command center
- Directory / Ticket kiosk
- Surveillance system
- Vehicle mount display
- Bathroom TV

Options

- DC power
- Touchscreen
- IP65 front protection
- Custom chassis & mounting
- HDMI decoder & extender
- HDMI quad display 1080p (K23")
- Multi monitor OSD control module
- 3G / HD / SD-SDI input module
- 12G / 4K60 / SD-SDI input module
- Auto dimming
- Manual dimming

Intentionally
Left
Blank

6mm aluminum front bezel



AP-K23
AP-K17
AP-K15
AP-K13

6mm aluminum front bezel
NEMA 4 / IP65 front protection



NAP-K23
NAP-K17
NAP-K15
NAP-K13

Aluminum front cover



DP-K23
DP-K17
DP-K15
DP-K13

Universal open frame



OP-K23
OP-K17
OP-K15
OP-K13

Chassis customization

- ▶ Dimension
- ▶ Color & Treatment
- ▶ Screen Printing
- ▶ Stainless Steel Bezel

Options — Touchscreen & Glass Protection

Touchscreen type	K23	K17	K15	K13
Projected Capacitive 10-point	✓	✓	✓	✓
e-Resistive 1-point Touch	✓	✓	✓	✓
Infrared 6-point Touch	✓			
Anti-reflective Glass			✓	
Vandal Proof Glass			✓	

* Only K13 apply 4-Wire Resistive

	TPC-10 Multi-touch	TRB e-Resistive		IR-06 Infrared
Technology	Projected Capacitive	5-Wire Resistive	4-Wire Resistive	Infrared
Touch Point	10 point	Single		6 point
Input Type	Finger or Capacitive Stylus	Finger or Stylus		Pen, Finger, Finger of gloved hand activation
Resolution	4096 x 4096	2048 x 2048		/
Touch Point Accuracy	± 2 mm	/		± 2 mm
Response Speed	< 5 ms	15 ms		≤ 8 ms
Activation Force	< 5 g	≤ 50 g	60-150g	No minimum touch activation force
Surface Hardness	6H	3H		6H
Light Transmission	> 85%	80% ± 3%	>75% ± 3%	> 85%
Haze	3% ↓	8% ± 3%	<12% ± 3%	3% ↓
Durability	50 million touches	10 million touches		Unlimited
Top Layer	1.1 mm Glass	ITO Film		/
Bottom Layer	0.7 mm Sensor Glass	ITO Glass		/
Thickness	2 mm	3.2 ± 0.2 mm	2.2 ± 0.2 mm	2 mm
Connector	USB	USB Type A		USB Type A
Compatibility	Windows / Linux / Android / Mac	Windows 7 / XP / Linux / Mac		Windows 7 / Windows 10

Options — DC Power

		12V	24V	48V	125V
Input rating	Input voltage	12-Volt	24-Volt	48-Volt	110-Volt
	Input range	9 ~ 18V	18 ~ 36V	36 ~ 75V	66 ~ 160V
Input current	No load	50 mA	50 mA	50 mA	35 mA
	Full load	4950 mA	2450 mA	1220 mA	749 mA
Output rating	Output voltage	12-Volt	12-Volt	12-Volt	12-Volt
	Output current	4.16A	4.16A	4.16A	6.25A
Efficiency		84%	85%	85%	91%

Part no. : 12VDC
24VDC
48VDC
125VDC

Options — Video Management & Transmission over Network

Embedded HDMI Decoder Module 1080p over IP

- Decodes RTSP, RTMP, UDP, HTTP, HLS protocols
- Supports video resolutions up to 1080p / 60Hz
- Unicast and multicast support
- Operates on standard 1000Mb Ethernet networks
- Built-in Web UI for configuration and control
- Excellent image quality with very low delay

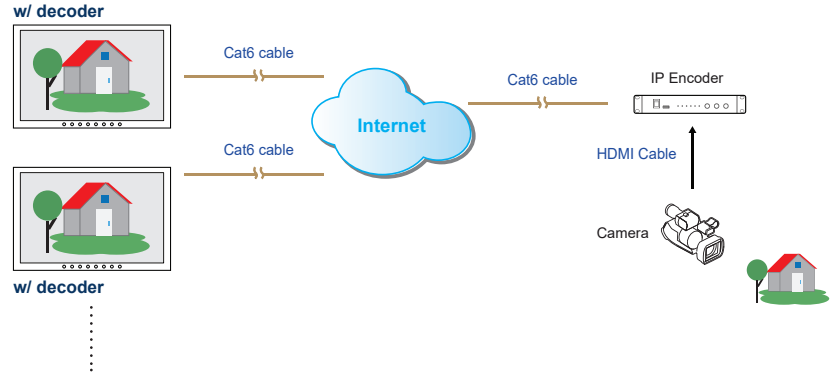

Part no.

Embedded HDMI Decoder Module : **UV-DE100F**
 Standalone HDMI Encoder : **UV-EN100F**

Embedded HDMI Receiver Module 1080p

- Extends the HDMI signal over a single Cat5/6 cable
- Supports video resolutions up to 1080p / 60Hz
- One to one just via Cat5/6 cable
- One to multi via network hub and Cat5/6 cable
- 100m maximum Cat5/6 cable distance
- Supports bi-directional IR communication
- High Speed HDMI 1.4 and HDCP 1.4 compliant
- No software or drivers required

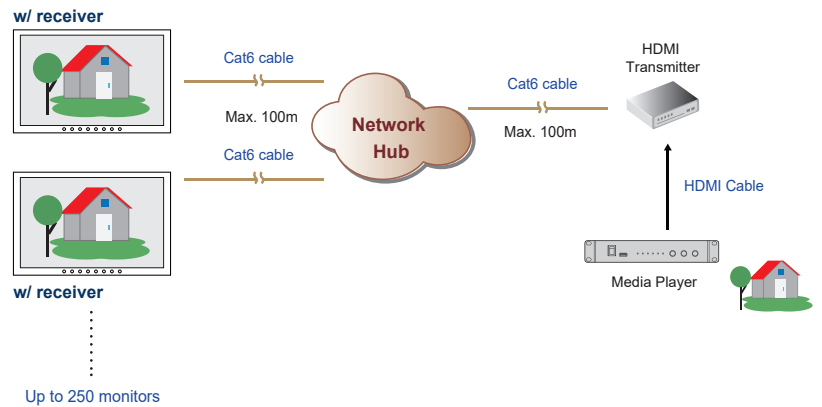

Part no.

Embedded HDMI Receiver Module : **UV-R100F**
 Standalone HDMI Transmitter : **UV-T100F**

Embedded HDMI Quad Display Module 1080p (For K23 series only)

- Allows 4 x HDMI inputs to be monitored simultaneously
- Quad split, panel left and full screen monitoring modes
- High speed HDMI 1.4 and HDCP 1.4 compliant
- Supports video resolutions up to 1080p / 60Hz
- Supports Scaler Up and Down function
- Control via local front panel and IR remote

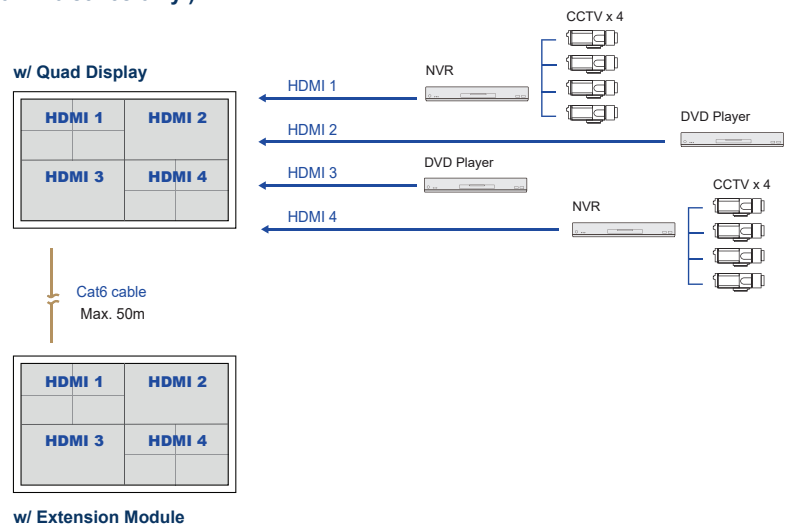

Part no.

Embedded HDMI Quad Display Module : **QD-1080**
 Embedded Quad Display Extension Module : **QD-E1080**

Options — Video Management & Transmission over Network

Embedded Multi Monitor OSD Control Module over serial

- Remote control the monitor OSD via RS-232C serial interface
- Daisy chain up to 64 monitors via Cat5/6 cable
- Individual ID for individual monitor OSD settings
- Power ON or OFF monitor
- Adjust brightness & audio
- Switch video sources

Up to 64 monitors
Up to 1,000m distance

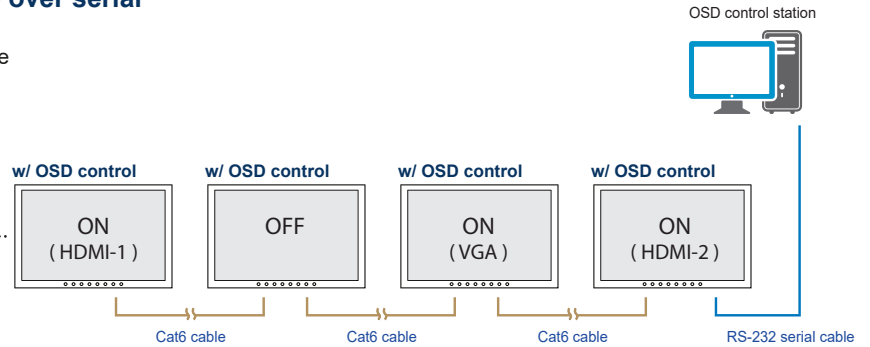

Part no.

Embedded Multi Monitor OSD Control Module : **MCS**

Embedded 3G / HD / SD-SDI Input Module
Embedded 12G / 4K60 / SD-SDI Input Module

- Intelligent SDI monitoring with broadcast quality scopes
- Supports multi-rate 3G / HD & 12G / 4K60 / SD-SDI format
- Provides input to output loop-through capability
- Auto format sensing & selection

Part no.

Embedded 3G / HD / SD-SDI Input Module : **SDI**

Embedded 12G / 4K60 / SD-SDI Input Module : **12G-SDI**

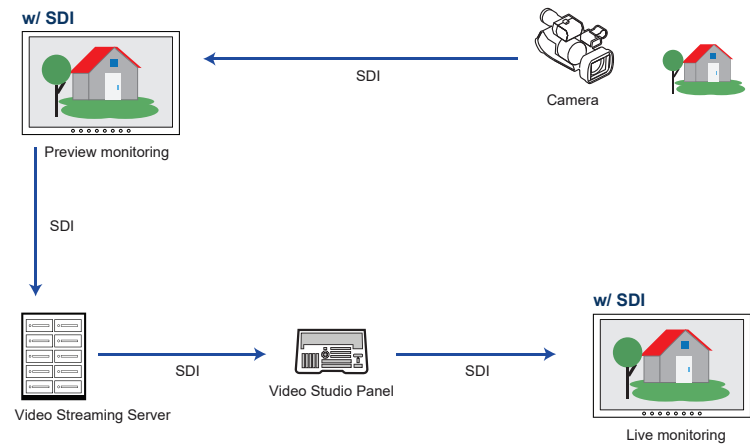

Embedded Auto Brightness Dimming Module

- Brightness changes according to its ambient brightness
- Its brightness change causes 10% increase or decrease

Part no.

Embedded Brightness Auto Dimming Module : **DA-01**

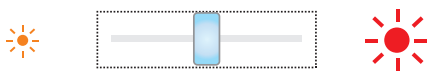

Embedded Manual Brightness Dimming Knob

- Easy-to-use IP54 dimming knob on the front panel
- One click causes 2% brightness increase or decrease
- Brightness adjustment from 0% to 100%

Part no.

Brightness Dimming Knob : **DS-01**

Product Specifications

LCD Panel	K23	K17	K15	K13
Panel size (diagonal)	23"	17.3"	15.6"	13"
Native resolution	3840 x 2160@60Hz			
Brightness (cd/m ²)	250	400	300	340
Contrast ratio (typ.)	1000 : 1	1000 : 1	800 : 1	1500 : 1
Colors	1.07 Billion, 10-bit	16.7 M, 8-bit	16.7 M, 8-bit	16.7 M, 8-bit
Viewing angle (L/R/U/D)	89/89/89/89			
Response time (ms)	25	16	30	29
Dot pitch (mm)	0.13725	0.0995	0.0897	0.0765
Display area (mm)	527.04H x 296.46V	382.12H x 214.94V	344.448H x 193.752V	293.76H x 165.24V
Surface treatment	Anti-glare			Glare
Surface hardness	3H			
Backlight type	LED			
MTBF (hrs)	30,000	15,000	20,000	15,000

Mounting	K23	K17	K15	K13
VESA mount (bundle)	100 x 100 mm	100 x 100 mm	100 x 100 mm	100 x 100 mm
Universal mount (ready)	OP only	OP only	OP only	OP only
Desktop stand (optional)	AP / NAP / DP	AP / NAP / DP	AP / NAP / DP	AP / NAP / DP
Panel mount (optional)	AP / NAP / DP	AP / NAP / DP	AP / NAP / DP	AP / NAP / DP

Power	K23	K17	K15	K13
Input	Auto-sensing 100 to 240VAC, 50 / 60Hz			
Max. Consumption :				
Screen on	55W	35W	30W	30W
Saving mode	2W			
Button off	1W			

Design	AP	NAP	DP	OP
Protection	6mm front bezel	NEMA 4 / IP65	Front cover	Open frame
Front panel	Black, RAL 9005			-
Rear casing	Black, RAL 9005			

Video	
Display port	DP 1.2 / HDCP 1.3
HDMI	HDMI 2.0 / HDCP 2.2 HDMI 1.4 / HDCP 1.4

Audio	
Audio output :	
Connector	3.5mm stereo jack
Resistance / Power level	30kΩ / 2.8V
Speaker :	
Dual stereo speaker	2W x 2

***When the audio output is connected, speaker output is OFF**

Display port input	
PC signal	3840 x 2160 x 60Hz 1920 x 1080 x 60Hz 1920 x 1200 x 60Hz 1600 x 1200 x 60Hz 1280 x 1024 x 60 / 75Hz 1024 x 768 x 60 / 70 / 75Hz 800 x 600 x 60 / 72 / 75Hz 720 x 400 x 70Hz 640 x 480 x 60 / 72 / 75Hz
Audio signal	2ch Linear PCM

HDMI input	
HDMI 2.0 / PC signal	Same as Display port
HDMI 1.4	3840 x 2160 x 30 Hz 1920 x 1080 x 50 / 60Hz (1080p) 1920 x 1080 x 25 / 30Hz (1080i) 1280 x 720 x 50 / 60Hz (720p) 720 x 480 x 50 / 60Hz (576p / 480p)
Audio signal	2ch Linear PCM

Product Specifications

Environment	
Operating temp.	0 to 55°C degree
Storage temp.	-20 to 60°C degree
Operating humidity	10~90%, non-condensing
Storage humidity	5 ~90%, non-condensing
Operating altitude	16,000 ft
Non-operating altitude	40,000 ft
Shock	10G acceleration (11ms duration)
Vibration	10~300Hz 0.5G RMS random

Compliance	
EMC	FCC & CE
Safety	CE / LVD & UKCA
Environment	REACH & RoHS3 / WEEE

Physical Dimension & Weight

K23"		AP-K23	NAP-K23	DP-K23	OP-K23
Product (W x D x H) :	mm	584.2 x 71.8 x 363.6		561.8 x 67 x 341	581.4 x 65.3 x 360.6
	inch	23 x 2.8 x 14.3		22.1 x 2.6 x 13.4	22.9 x 2.6 x 14.2
Net weight		9 kg / 19.8 lb	10.4 kg / 22.9 lb	7.9 kg / 17.4 lb	6.7 kg / 14.7 lb
Packing (W x D x H) :	mm	659 x 117 x 640			
	inch	25.9 x 4.6 x 25.2			
Gross weight		12.7 kg / 27.9 lb	14.1 kg / 31 lb	11.6 kg / 25.5 lb	10.4 kg / 22.9 lb

K17"		AP-K17	NAP-K17	DP-K17	OP-K17
Product (W x D x H) :	mm	440.5 x 54.1 x 293		417.5 x 48.9 x 270.4	437.5 x 47.6 x 290
	inch	17.3 x 2.1 x 11.5		16.4 x 1.9 x 10.6	17.2 x 1.9 x 11.4
Net weight		5.2 kg / 11.4 lb	5.9 kg / 13 lb	4.3 kg / 9.5 lb	3.4 kg / 7.5 lb
Packing (W x D x H) :	mm	615 x 113 x 523			
	inch	24.2 x 4.4 x 20.6			
Gross weight		8 kg / 17.6 lb	8.7 kg / 19.1 lb	7.1 kg / 15.6 lb	6.2 kg / 13.6 lb

K15"		AP-K15	NAP-K15	DP-K15	OP-K15
Product (W x D x H) :	mm	399 x 53.6 x 261.6		376 x 49.1 x 238.6	396 x 47.6 x 258.6
	inch	15.7 x 2.1 x 10.3		14.8 x 1.9 x 9.4	15.9 x 1.9 x 10.2
Net weight		4.7 kg / 10.3 lb	5.3 kg / 11.7 lb	4.1 kg / 9 lb	3.5 kg / 7.7 lb
Packing (W x D x H) :	mm	615 x 113 x 523			
	inch	24.2 x 4.4 x 20.6			
Gross weight		7.3 kg / 16.1 lb	7.9 kg / 17.4 lb	6.7 kg / 14.7 lb	6.1 kg / 13.4 lb

K13"		AP-K13	NAP-K13	DP-K13	OP-K13
Product (W x D x H) :	mm	355 x 54.9 x 252.3		332.4 x 50.2 x 231.7	355 x 50.2 x 252.3
	inch	14 x 2.2 x 9.9		13.1 x 2 x 9.1	14.0 x 2 x 9.9
Net weight		- kg / - lb	- kg / - lb	- kg / - lb	- kg / - lb
Packing (W x D x H) :	mm	615 x 113 x 523			
	inch	24.2 x 4.4 x 20.6			
Gross weight		- kg / - lb	- kg / - lb	- kg / - lb	- kg / - lb

* All dimensions stated are subject to change if options are selected / integrated to base model part codes

UltraView Family

UltraView series covers a full range of professional LCD display sizes. Please select from the below the most suitable model for your application.

Sales Inquiry

inquiry@austin-hughes.com

Technical Support

support@austin-hughes.com

4K

- K55"
- K43"
- K32"
- K27"
- K23"
- K17"
- K15"
- K13"

FHD

- F55" ● F21"
- F43" ● F19"
- F32" ● F17"
- F27" ● F15"
- F23" ● F13"

WXUGA (1920 x 1200)

- X24"
- X17"

Regular

- W19" (1440 x 900)
- 20" (1600 x 1200)
- 19" (1280 x 1024)
- 17" (1280 x 1024)
- 15" (1024 x 768)
- 12" (800 x 600)
- 10" (800 x 600)

High Brightness

4K

- K55"
- K43"

Sunlight Readable Brightness

FHD

- F55" ● F21"
- F43" ● F19"
- F32" ● F17"
- F24" ● F15"

Regular

- W19" (1440 x 900)
- 19" (1280 x 1024)
- 17" (1280 x 1024)



As a leading global IT manufacturer,

Austin Hughes provides TAA-compliant data center solutions, manufactures and assembles products in strategic TAA-certified locations.

AUSTIN HUGHES®

Austin Hughes has an extensive distribution network, including the Americas, EMEA, APAC & ASEAN.

Contact your nearest sales office for details of local representation

Americas

Austin Hughes Solutions Inc.
21375 Cabot Blvd
Hayward, CA 94545
United States

inquiry-americas@austin-hughes.com

EMEA

Austin Hughes Europe Ltd.
Unit 1, Chancery Gate Business Centre
Manor House Avenue
Southampton, SO15 0AE
United Kingdom

inquiry-emea@austin-hughes.com

APAC

Austin Hughes Electronics Ltd.
Unit 3608-12, Cable TV Tower
9 Hoi Shing Road, Tsuen Wan
Hong Kong

inquiry-apac@austin-hughes.com

ASEAN

Austin Hughes Pte. Ltd.
1 Bukit Batok Crescent,
#04-27 WCEGA Plaza
Singapore 658064

inquiry-asean@austin-hughes.com

Distributed by:

Distributor by country on application

Please ask for details of other products from Austin Hughes. Every effort has been made to ensure that the information contained herein is correct. There is a possibility that the image(s) shown may not be exactly the same as the final product. The company reserves the right to modify product specifications without prior notice and assumes no responsibility for any error which may appear in this publication.

All brand names, logo and registered trademarks are properties of their respective owners.
Copyright 2025 Austin Hughes Electronics Ltd. All rights reserved.