

## User Manual

17" High Brightness FHD 1080p LED-backlit LCD 1000 cd/m<sup>2</sup>



### RP-HF117

1U LED-backlit LCD Drawer

Options :

- SDI
- DVI-D / Audio
- Touchscreen / DC power

FC CE UK CA  REACH

Designed and manufactured by Austin Hughes

751

## Legal Information

First English printing, January 2024

Information in this document has been carefully checked for accuracy; however, no guarantee is given to the correctness of the contents. The information in this document is subject to change without notice. We are not liable for any injury or loss that results from the use of this equipment.

## Safety Instructions

**Please read all of these instructions carefully before you use the device. Save this manual for future reference.**

- Unplug equipment before cleaning. Don't use liquid or spray detergent; use a moist cloth.
- Keep equipment away from excessive humidity and heat. Preferably, keep it in an air-conditioned environment with temperatures not exceeding 40° Celsius (104° Fahrenheit).
- When installing, place the equipment on a sturdy, level surface to prevent it from accidentally falling and causing damage to other equipment or injury to persons nearby.
- When the equipment is in an open position, do not cover, block or in any way obstruct the gap between it and the power supply. Proper air convection is necessary to keep it from overheating.
- Arrange the equipment's power cord in such a way that others won't trip or fall over it.
- If you are using a power cord that didn't ship with the equipment, ensure that it is rated for the voltage and current labeled on the equipment's electrical ratings label. The voltage rating on the cord should be higher than the one listed on the equipment's ratings label.
- Observe all precautions and warnings attached to the equipment.
- If you don't intend on using the equipment for a long time, disconnect it from the power outlet to prevent being damaged by transient over-voltage.
- Keep all liquids away from the equipment to minimize the risk of accidental spillage. Liquid spilled on to the power supply or on other hardware may cause damage, fire or electrical shock.
- Only qualified service personnel should open the chassis. Opening it yourself could damage the equipment and invalidate its warranty.
- If any part of the equipment becomes damaged or stops functioning, have it checked by qualified service personnel.

## What the warranty does not cover

- Any product, on which the serial number has been defaced, modified or removed.
- Damage, deterioration or malfunction resulting from:
  - Accident, misuse, neglect, fire, water, lightning, or other acts of nature, unauthorized product modification, or failure to follow instructions supplied with the product.
  - Repair or attempted repair by anyone not authorized by us.
  - Any damage of the product due to shipment.
  - Removal or installation of the product.
  - Causes external to the product, such as electric power fluctuation or failure.
  - Use of supplies or parts not meeting our specifications.
  - Normal wear and tear.
  - Any other causes which does not relate to a product defect.
- Removal, installation, and set-up service charges.

## Regulatory Notices Federal Communications Commission (FCC)

This equipment has been tested and found to comply with the limits for a Class B digital device, pursuant to Part 15 of the FCC rules. These limits are designed to provide reasonable protection against harmful interference in a residential installation.

Any changes or modifications made to this equipment may void the user's authority to operate this equipment. This equipment generates, uses, and can radiate radio frequency energy and, if not installed and used in accordance with the instructions, may cause harmful interference to radio communications.

However, there is no guarantee that interference will not occur in a particular installation. If this equipment does cause harmful interference to radio or television reception, which can be determined by turning the equipment off and on, the user is encouraged to try to correct the interference by one or more of the following measures:

- Re-position or relocate the receiving antenna.
- Increase the separation between the equipment and receiver.
- Connect the equipment into an outlet on a circuit different from that to which the receiver is connected.

# Contents

## < Part. 1 > RP-HF117

1.1	Package Content	P.1
1.2	Structure Diagram & Dimension	P.1
1.3	Installation	P.3

## < Part. 2 > Specifications / OSD / Remote Controller

2.1	Product Specifications	P.4
2.2	On-screen Display Operation ( OSD )	P.6

## < Part. 3 > Options

3.1	3G / HD / SD-SDI Broadcast-grade input	P.8
3.2	Speaker, Display port, DVI-D, BNC	P.9
3.3	F17" Touchscreen : Resistive ( 1-point touch )	P.10
3.4	DC Power : 12V / 24V / 48V / 125V / 250V	P.12

## Before Installation

- It is very important to mount the equipment in a suitable cabinet or on a stable surface.
- Make sure the place has a good ventilation, is out of direct sunlight, away from sources of excessive dust, dirt, heat, water, moisture and vibration.

## Unpacking

The equipment comes with the standard parts shown in package content. Check and make sure they are included and in good condition. If anything is missing, or damaged, contact the supplier immediately.

## How To Clean Your LCD Monitor



### Caution :

- To avoid the risk of electric shock, make sure your hands are dry before unplugging your monitor from or plugging your monitor into an electrical outlet.
- When you clean your monitor, do not press down on the LCD screen. Pressing down on the screen can scratch or damage your display. Pressure damage is not covered under warranty.
- Use only cleansers made specifically for cleaning monitors and monitor screens. Cleansers not made to clean monitors and monitor screens can scratch the LCD display or strip off the finish.
- Do not spray any kind of liquid directly onto the screen or case of your monitor. Spraying liquids directly onto the screen or case can cause damage which is not covered under warranty.
- Do not use paper towels or abrasive pads to clean your monitor. Using an abrasive pad or any wood based paper product such as paper towels can scratch your LCD screen.

## Cleaning Your Monitor

To clean your LCD safely, please follow these steps :

- ① Disconnect the power cord.
- ② Gently wipe the surface using a clean, dry microfiber cloth. Use as little pressure as possible.

## Cleaning Tough Marks and Smudges

To remove tough marks and smudges, please follow these steps :

- ① Disconnect the power cord.
- ② Spray a small amount of non-abrasive cleanser on a microfiber cloth.



**Caution : Do not spray or apply any liquids directly onto the monitor. Always apply the solution to your microfiber cloth first, not directly on the parts you are cleaning.**

- ③ Gently wipe the surface. Use as little pressure as possible.
- ④ Wait until your monitor is completely dry before plugging it in and powering it up.

## < Part 1 >

### < 1.1 > Package Content

RP-HF117



#### RP-HF117 unit X 1

- 6ft VGA cable X 1
- Power cord X 1
- M6 screw, cage nut & cup washer X 8



The above package content is only for the pure model ( VGA and HDMI only ). It varies with options such as SDI, DVI-D, audio, touchscreen & DC power.

### < 1.2 > Structure Diagram

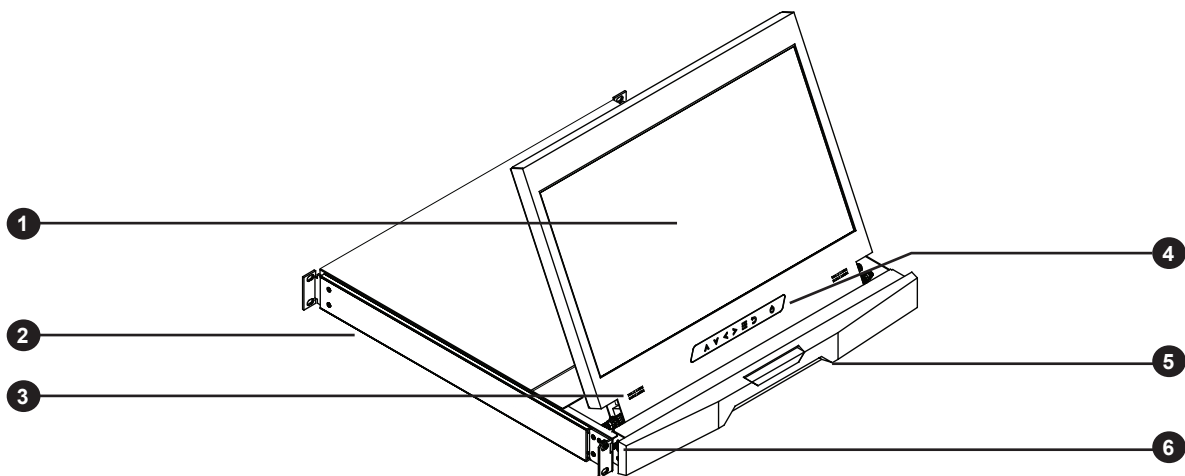

① LCD panel

② Installation Slide

③ Audio speaker ( optional )

④ LCD OSD membrane

⑤ Carry handle to release the 2-pt lock

⑥ 2-point lock



## < 1.2 > Dimension

### Front View

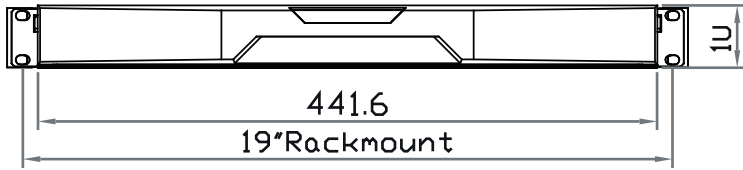

### Rear View

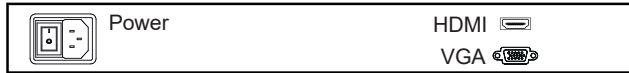

### Side View

UNIT : mm  
1mm = 0.03937 inch

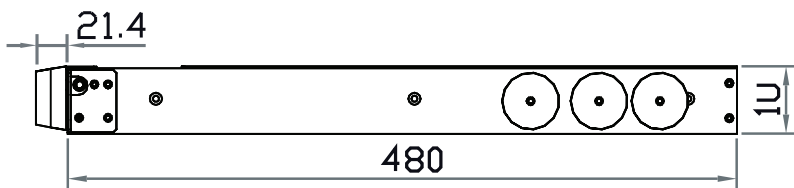

### Top View

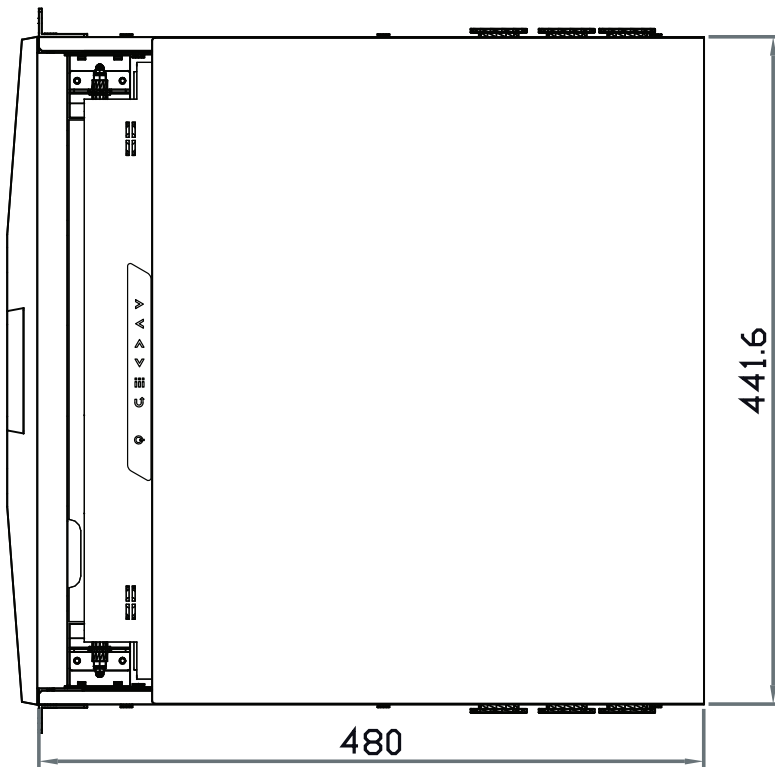

Model	Product Dimension (W x D x H)	Packing Dimension (W x D x H)	Net Weight	Gross Weight
RP-HF117	441.6 x 480 x 44 mm 17.4 x 18.1 x 1.73"	588 x 758 x 120 mm 23.1 x 29.8 x 4.7"	11 kg 24.2 lb	15 kg 33 lb

**!** The weight is only for the pure models. It varies with accessories & options such as SDI, DVI-D, audio, touchscreen & DC power.

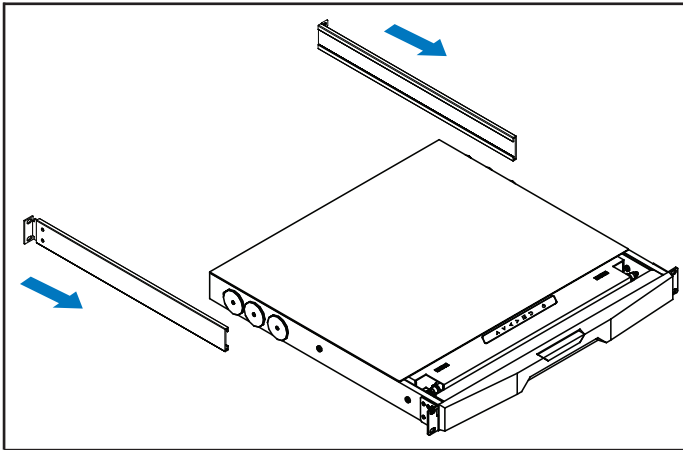

**Step 1**

- Insert the left and right rear mounting brackets into the display drawer.

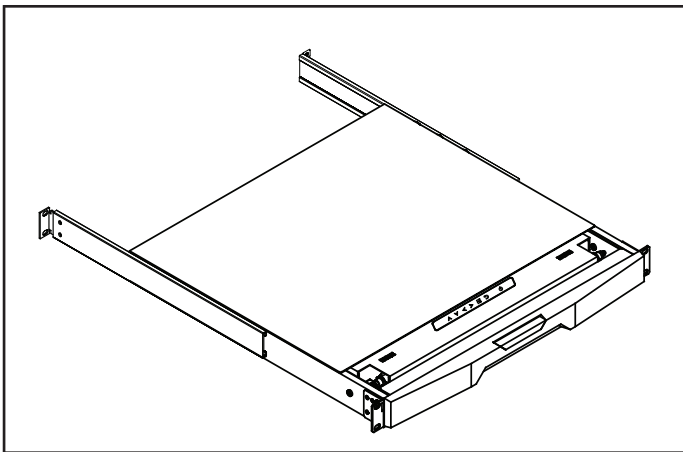

**Step 2**

- Measure the depth of the front and rear mounting rails.
- Align each rear mounting bracket to a suitable length.

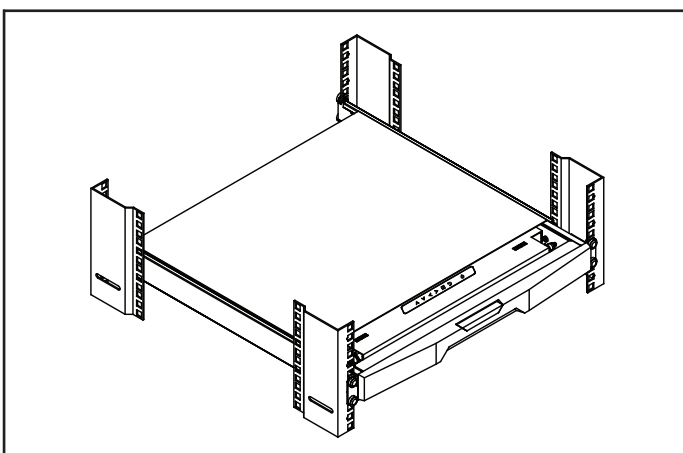

**Step 3**

**Complete the installation**

- Fix the display drawer into the rack.

 **M6 screw, cage nut & cup washer x 8 are provided.**



**After use the drawer**

Basically, user can push in the drawer back to park position by releasing the left & right slide lock arrow (as long as the drawer starts moving, he/she can release their finger right away, holding the arrow is not necessary).

## < Part 2 >

### < 2.1 > Product Specifications

<b>LED-backlit LCD Panel</b>	Panel Size ( diagonal )	17.3-inch Widescreen TFT color LED-backlit LCD
	Display pixel ( dots x lines )	1920 x 1080
	Brightness ( typ. )	1000
	Contrast Ratio ( typ. )	600:1
	Color	16.7 M, 8-bit
	Viewing Angle ( L/R/U/D )	85/85/85/85
	Response Time ( ms )	5.5
	Dot pitch ( mm )	0.1989
	Display Area ( mm )	381.888H x 214.812V
	Surface treatment	Anti-glare, Hard-coating
	Surface hardness	3H
	Backlight Type	LED
MTBF ( hrs )	50,000	

<b>Video Connectivity</b>	Digital	HDMI	HDMI 1.4, HDCP 1.4
		DVI	DVI-D, TMDS single link
		Display Port	DP 1.0 / HDCP 1.3
	Analog	VGA	Analog 0.7Vp-p
		Composite ( BNC )	NTSC & PAL
	Plug & Play	DVI / VGA	VESA EDID structure 1.3
	Synchronization	VGA	Separate, Composite & SOG

<b>Audio Connectivity</b>	Audio Input	Connector	3.5mm stereo jack
		Impedance / Power level	30k $\Omega$ / 750mV
	Audio Output	Connector	3.5mm stereo jack
		Resistance / Power level	30k $\Omega$ / 2.8V
	Speaker	Dual Stereo Speaker	2W x 2

\* When the audio output is connected, speaker output is OFF

<b>Power</b>	Power Supply	Range	Auto-sensing 100 to 240VAC, 50 / 60Hz
	Power Consumption	Screen ON	Max. 39W
		Power saving mode	Max. 2W
		Power button OFF	Max. 1W

<b>Compliance</b>	EMC	FCC & CE
	Safety	CE / LVD & UKCA
	Environmental	RoHS3 & REACH / WEEE



Environmental Conditions	Operating	Temperature	0 to 55°C degree
		Humidity	10~90%, non-condensing
		Altitude	16,000 ft
	Storage / Non-operating	Temperature	-20 to 60°C degree
		Humidity	5~90%, non-condensing
		Altitude	40,000 ft
		Shock	10G acceleration (11ms duration)
		Vibration	10~300Hz 0.5G RMS random







Physical Specification	Product ( W x D x H )	441.6 x 480 x 44 mm 17.4 x 18.9 x 1.73 inch
	Packing ( W x D x H )	588 x 758 x 120 mm 23.1 x 29.8 x 4.7 inch
	Net Weight	11 kg / 24.2 lb
	Gross Weight	15 kg / 33 lb

\* All dimensions stated are subject to change if options are selected / integrated to base model part codes

Applicable Format	DVI-D / VGA Input	PC Signal	1920 x 1080 x 60Hz	
			1680 x 1050 x 60Hz	
			1440 x 900 x 60Hz	
			1360 x 768 x 60Hz	
			1280 x 1024 x 60Hz	
			1280 x 768 x 60Hz	
			1280 x 720 x 60Hz	
			1152 x 864 x 60Hz	
			1024 x 768 x 60Hz	
			800 x 600 x 60Hz	
	640 x 480 x 60Hz			
	HDMI Input	Audio Signal	2ch Linear PCM	
			PC Signal	Same as VGA
	HDMI Input	HDMI 1.4	1920 x 1080 x 50 / 60Hz ( 1080p )	
			1920 x 1080 x 25 / 30Hz ( 1080i )	
			1280 x 720 x 50 / 60Hz ( 720p )	
			720 x 480 x 50 / 60Hz ( 576p / 480p )	
			Audio Signal	2ch Linear PCM
				PC Signal
	Display port Input	PC Signal	1920 x 1080 x 60Hz	
1680 x 1050 x 60Hz				
1440 x 900 x 60Hz				
1360 x 768 x 60Hz				
1280 x 1024 x 60Hz				
1280 x 768 x 60Hz				
1280 x 720 x 60Hz				
1152 x 864 x 60Hz				
1024 x 768 x 60Hz				
800 x 600 x 60Hz				
640 x 480 x 60Hz				
Audio Signal			2ch Linear PCM	







## < 2.2 > On-screen Display Operation ( OSD )



Membrane Switch	Function
	Turn the monitor on or off
	Display the OSD menu Act as an Enter key to select screen setting options
   	Scroll through menu options and adjust the displayed control
	Exit the OSD screen Go back to the previous on-screen sub-menu or main menu

Remark : All LED touch buttons in **WHITE** light.

The LED of **Power**  touch button will flash continuously when there is no signal input.

- ① All the LED touch buttons will automatically turn off after 10 minutes of idle status ( except the **Power**  ).
- ② Light up all membrane buttons, please press any button for 1 - 2 seconds ( except the **Power**  ).
- ③ Select another video input (only available for models with multiple video input) :
  - ( a ) Press the button  to call up the on-screen video mode on top right corner.
  - ( b ) Use up/down arrow   to the select the video input
  - ( c ) Press the button  to confirm the selection

### ① Picture

- Picture mode : Standard / Vivid / Soft / User mode to choose
- Brightness : Adjust background black level of the screen image
- Contrast : Adjust the difference between the image background (black level) and the foreground (white level)
- Hue: Adjust the screen hue value
- Saturation : Adjust the saturation of the image color
- Picture size : Adjust the image size
- Color temp : Standard / Cool / Warm / User to choose
- Noise reduce : Reduce the noise of the image
- Sharpness : Adjust the image from weak to sharp

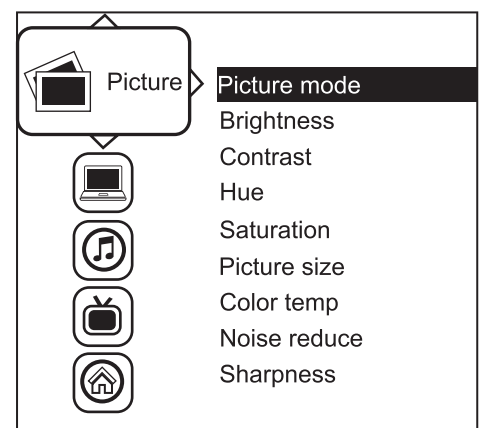

② **PC**

- Auto adjust : Automatically adjust sizes, centers and fine tunes the video signal to eliminate waviness and distortion.
- Clock : Adjust the clock value
- Phase : Adjust the phase value
- H. Position : Align the screen image left or right
- V. Position : Align the screen image up or down

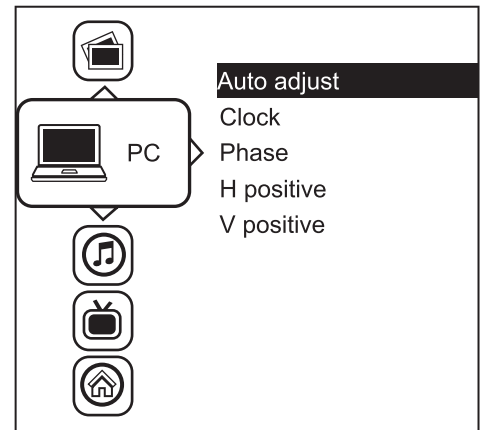

③ **Audio**

- Audio mode : Movie / Voice / Normal / Music mode to choose
- Volume : Adjust the volume of sound
- Bass : Set the value of bass sound
- Treble : Set the value of treble sound
- Balance : Set the balance value of treble and bass sound
- Analog TV audio : Set the value of analog TV audio sound
- Mute : Turn off the surrounding sound

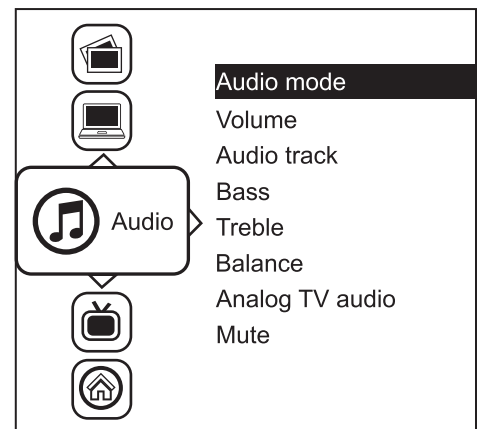

④ **MISC**

- Language : Select the language in which the OSD menu is displayed - English
- Sleep timer : Set the off time
- PIP mode : Adjust picture in picture setting
- PIP position : Enter into PIP position
- PIP source : Enter into the Sub source and sound source
- System reset : Return the adjustment back to factory setting
- Information : Select for Help

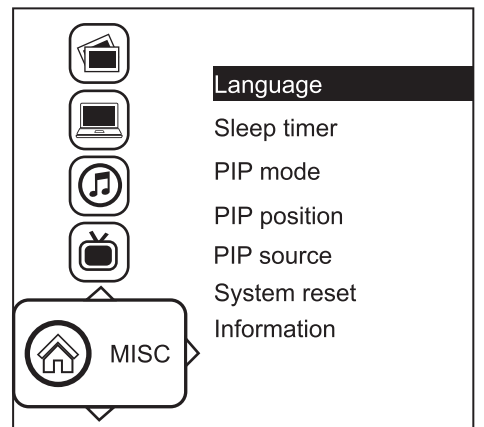

< Part 3 >

< 3.1 > Options : 3G / HD / SD-SDI input

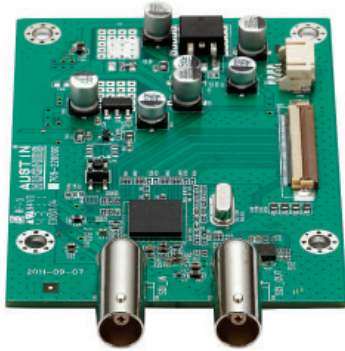

Austin Hughes' SDI input is an ideal solution for the broadcast-grade video and high resolution CCTV market.

Designed for use with CyberView displays, a SDI input module can support up to 1080p @60Hz resolution without using additional space or power and it comes standard with a 2-year warranty.

\* SDI option comes with speakers.

**SDI**

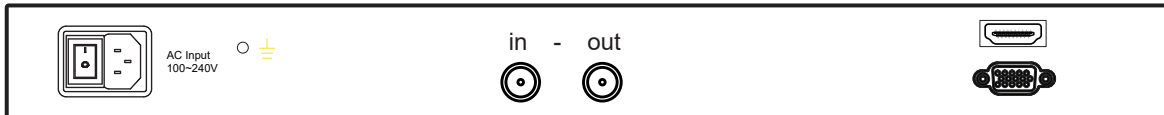

**!** Chassis extension in depth to 530mm ( 20.9" )

<b>INPUT</b>	3G-SDI IN	BNC x 1 / 0.8Vp-p ( 75 ohm )
	3G-SDI OUT	BNC x 1 / Active through, equalized & relocked

<b>Standard Compliance</b>	Video	SMPTE 425M / 274M / 296M / 125M ITU-R BT.656
	Audio	SMPTE 299M / 272M-C

<b>Compatible Video Format</b>	3G-SDI	1080p	@60 / 50Hz, 4:2:2
		1080p	@30 / 25 / 24Hz, 4:4:4
		1080i	@60 / 50Hz, 4:4:4
		720p	@60 / 50Hz, 4:4:4
	HD-SDI	1080p	@30 / 25 / 24Hz, 4:2:2
		1080i	@60 / 50Hz, 4:2:2
720p		@60 / 50Hz, 4:2:2	
SD-SDI	480i	@60Hz, 4:2:2	
ITU-R BT.656	576i	@50Hz, 4:2:2	

<b>Compatible Audio Format</b>	3G-SDI	48kHz, 16 / 20 / 24 bit, 2 CH, Synchronized Video
	HD-SDI	48kHz, 16 / 20 / 24 bit, 2 CH, Synchronized Video
	SD-SDI	48kHz, 16 / 20 / 24 bit, 2 CH, Synchronized / Asynchronous Video

<b>Max. Transmission Distance 75 ohm coaxial cable</b>	3G-SDI	150m at 2.97Gb/s
	HD-SDI	250m at 1.485Gb/s
	SD-SDI	480m at 270Mb/s

### Speaker Option

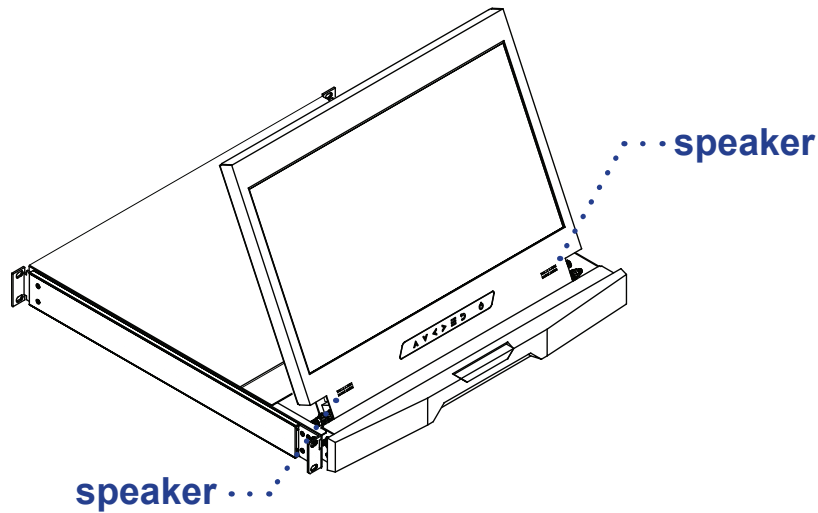

### DP Option

- Display Port ( DP 1.0, HDCP 1.3 )
- Speaker

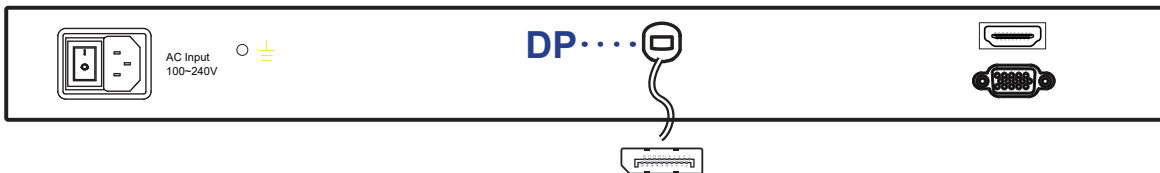

**!** Chassis extension in depth to 530mm ( 20.9" )

### DVI-D Option

- DVI-D ( DVI-D, TMDS single link )
- Audio input & output
- Speaker

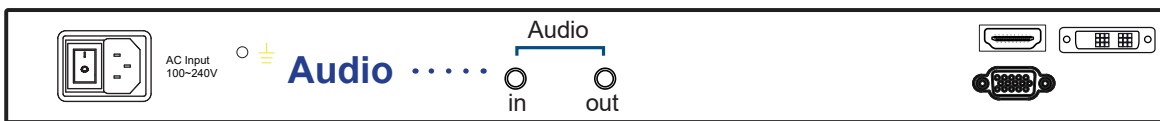

**!** Chassis extension in depth to 530mm ( 20.9" )

### BNC Option

- BNC ( Composite, BNC )
- Audio IN
- Speaker

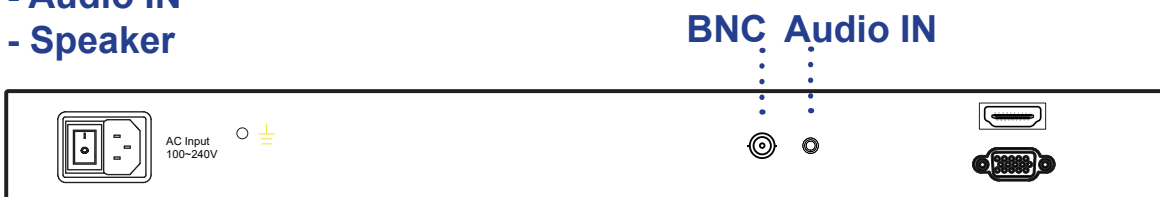

**!** Chassis extension in depth to 530mm ( 20.9" )

### < 3.3 > Options : Touchscreen & driver



#### Projected Capacitive 10-pt Touch screen Specification

<b>Model</b>	<b>TPC-10</b> Multi-touch
<b>Technology</b>	Projected Capacitive
<b>Touch Point</b>	10
<b>Input Type</b>	Finger or Capacitive Stylus
<b>Resolution</b>	4096 x 4096
<b>Touch Point Accuracy</b>	± 2 mm
<b>Response Speed</b>	< 5 ms
<b>Activation Force</b>	< 5 g
<b>Surface Hardness</b>	6H
<b>Light Transmission</b>	> 85%
<b>Haze</b>	3% ↓
<b>Durability</b>	50 million touches
<b>Top Layer</b>	1.8 mm Glass
<b>Bottom Layer</b>	0.7 mm Sensor Glass
<b>Thickness</b>	2.7 ± 0.1 mm
<b>Connector</b>	USB
<b>Compatibility</b>	Linux / Android / Windows / Mac

#### Resistive 1-pt Touchscreen Specification

<b>Model</b>	<b>TRB</b> e-Resistive
<b>Technology</b>	5-Wire Resistive
<b>Touch Point</b>	Single
<b>Method</b>	Stylus or Finger
<b>Activation Force</b>	≤ 50g / Stylus=R0.8
<b>Durability</b>	10 million touches
<b>Response Time</b>	15 ms
<b>Optical Transmittance</b>	80% ± 3%
<b>Surface Hardness</b>	3H
<b>Haze</b>	8% ± 3%
<b>Glass</b>	2.2 ± 0.2 mm
<b>Connector</b>	USB Type A
<b>Compatibility</b>	Windows 7 / XP / Vista, Linux

- USB touchscreen package includes 1 x 6ft USB cable, quick reference guideline and CD disc
- For detailed information, please refer to the attached CD disc
- As the touchscreen unit is not made of toughened glass, please handle it carefully



### USB Touchscreen



### TPC-10 Driver



Connect the USB cable from the USB port on the LCD to a computer. The touch screen supports easy Plug-and-Play operations. There is no need to install additional drivers on the computer.

### TRB Driver

**Please follow the below steps to setup the touch screen:-**

- Step 1.** Run the bundled CD disc or download the driver from the link below :  
<http://www.austin-hughes.com/resources/driver/rackmount-display>
- Step 2.** Double click the Setup.exe
- Step 3.** Follow the installation instruction to finish the setup
- Step 4.** After installation, run the TouchKit program & the “4 point calibration”



Please do the initial calibration after the first setup

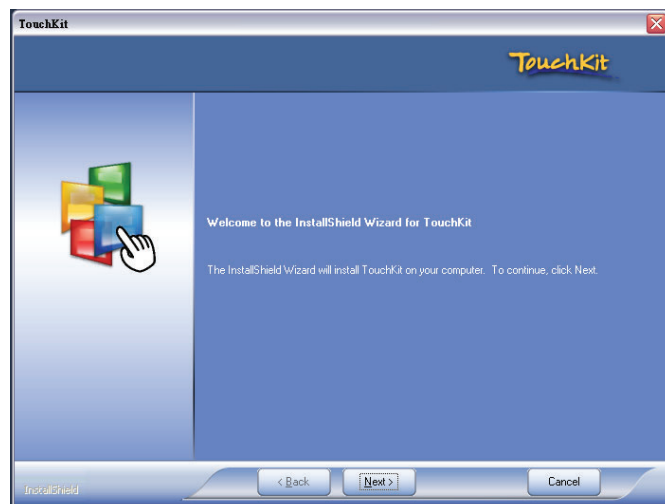

## < 3.4 > Options : DC Power

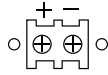

Model	12V	24V	48V	125V	250V
<b>Input rating</b>					
Input voltage:	12-Volt	24-Volt	48-Volt	110-Volt	300-Volt
Input range:	9 ~ 18V	18 ~ 36V	36 ~ 75V	66 ~ 160V	180 ~ 425V
Input current					
- No load	50 mA	50 mA	50 mA	35 mA	10 mA
- Full load	4950 mA	2450 mA	1220 mA	749 mA	600 mA
<b>Output rating</b>					
Output voltage:	12-Volt	12-Volt	12-Volt	12-Volt	12-Volt
Output current:	4.16A	4.16A	4.16A	6.25A	12.5A
<b>Efficiency</b>	84%	85%	85%	91%	86%

### DC power



\*\*\* For DC power option :

- ( 1 ) If the unit with LCD, earthing may be required
- ( 2 ) DC option excludes AC power adapter and power cord.
- ( 3 ) Chassis extension in depth to 530mm ( 20.9" )

The company reserves the right to modify product specifications without prior notice and assumes no responsibility for any error which may appear in this publication.

All brand names, logo and registered trademarks are properties of their respective owners.

Copyright 2024 Austin Hughes Electronics Ltd. All rights reserved.