

Front view

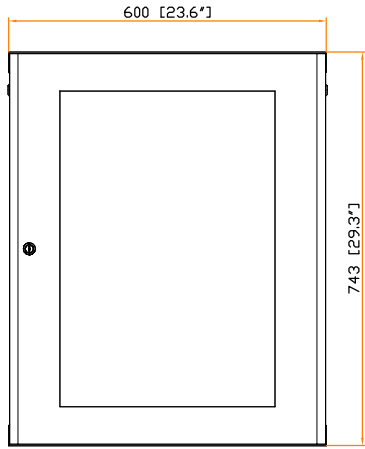

Front view (w/o door)

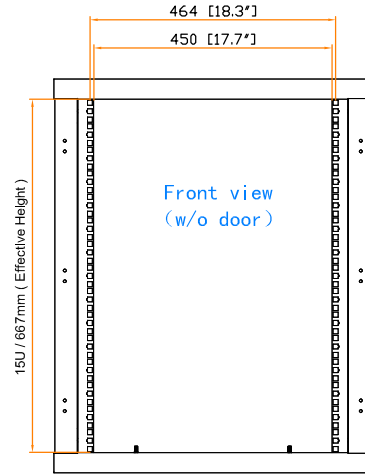

Side view

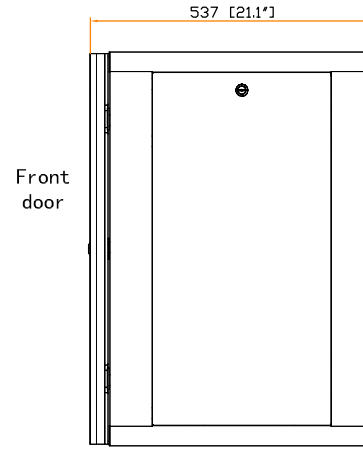

Rear view

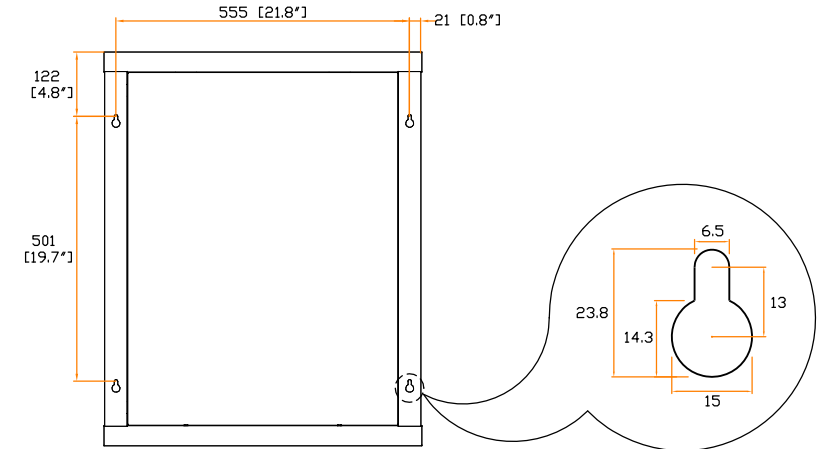

Top view

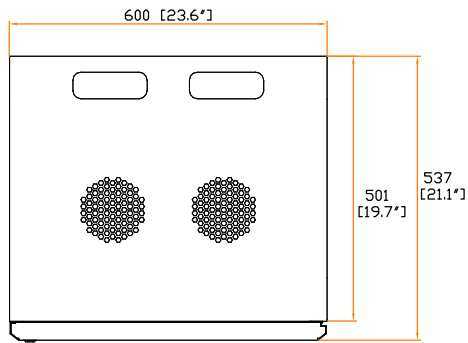

Front door

Bottom view

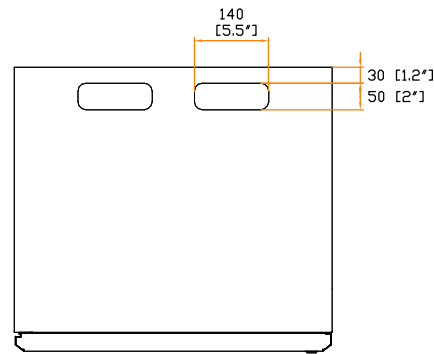

Front door

19" rail position

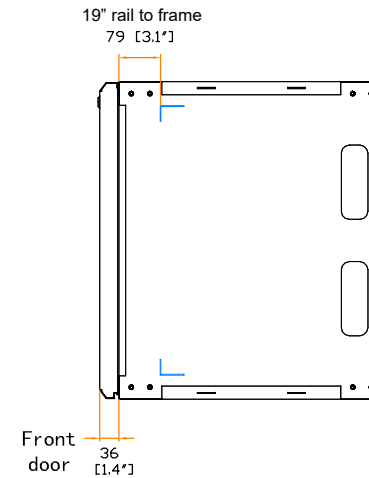

The company reserves the right to modify product specifications without prior notice and assumes no responsibility for any error which may appear in this publication.

Copyright 2020 Austin Hughes Electronics Ltd. All rights reserved.

Dimension (Overall)	:	600 (W) x 537 (D) x 743 (H) mm / 23.6 (W) x 21.1 (D) x 29.3 (H) in.
Dimension (Effective)	:	600 (W) x 501 (D) x 667 (H) mm / 23.6 (W) x 19.7 (D) x 26.3 (H) in.
Net Weight	:	- kg / - lb
Color	:	White (RAL-9016)
Static Loading	:	50 kg / 110 lb
Environmental	:	RoHS3 & REACH compliant by SGS

Unit : mm [in.]