

Front view

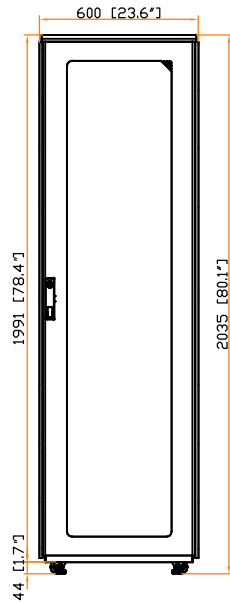

Rear view

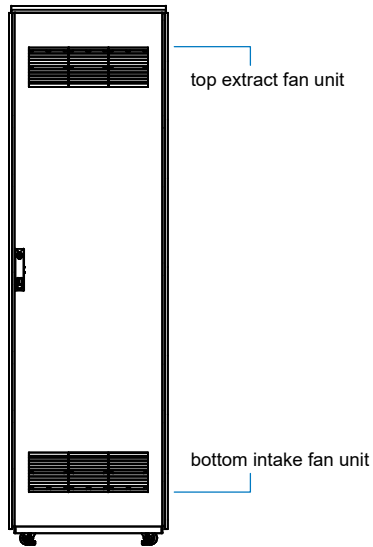

Side view

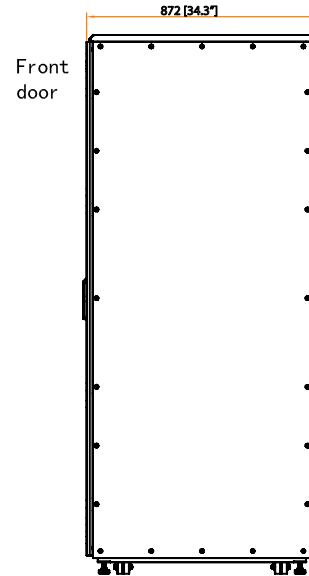

Top view

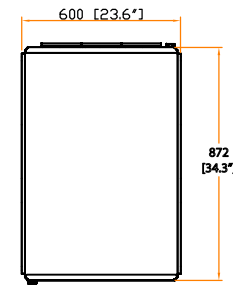

Bottom view

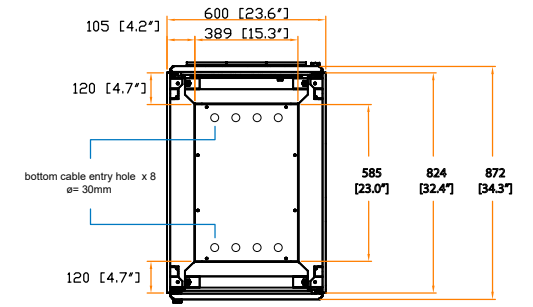

Front door

Front door

19" rail position

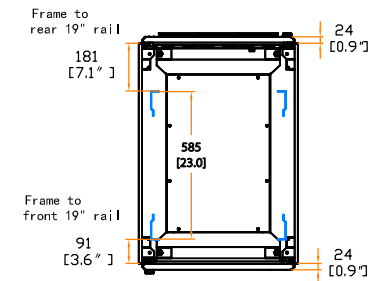

Front door

Unit : mm [inch]



The company reserves the right to modify product specifications without prior notice and assumes no responsibility for any error which may appear in this publication.

Copyright 2020 Austin Hughes Electronics Ltd. All rights reserved.

Dimension (Overall) : 600 (W) x 872 (D) x 2035 (H) mm
23.6 (W) x 34.3 (D) x 80.1 (H) inch

Dimension (Effective) : 593 (W) x 827 (D) x 1868 (H) mm
23.3 (W) x 32.6 (D) x 73.5 (H) inch

Net Weight : 181 kg / 398.2 lb

Color : White (RAL-9016)

Static Loading : 1500 kg / 3300 lb

Environmental : RoHS3 & REACH compliant by SGS