

Front view

Rear view

Side view

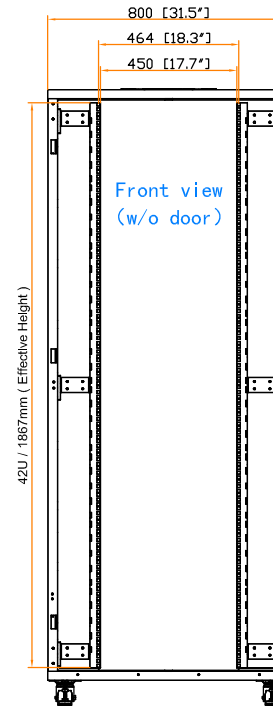

Side view(w/o side panel)

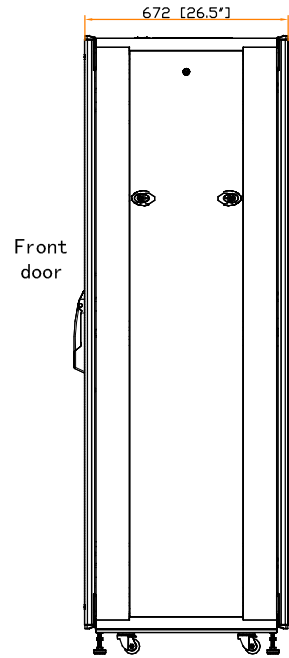
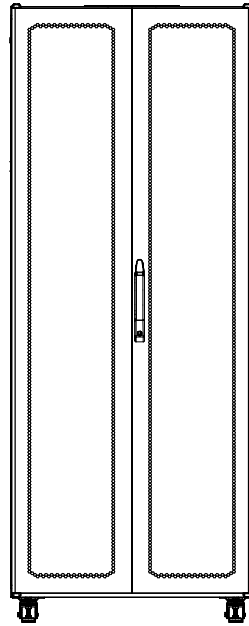
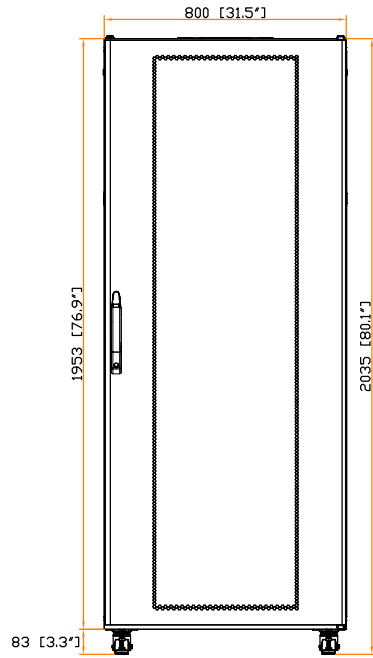
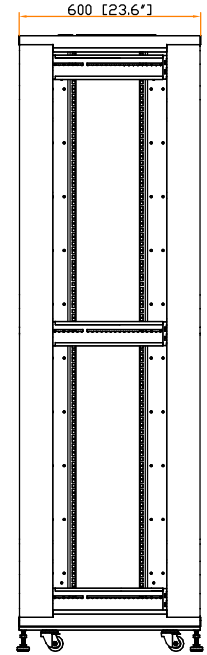

Top view

Bottom view

19" rail position

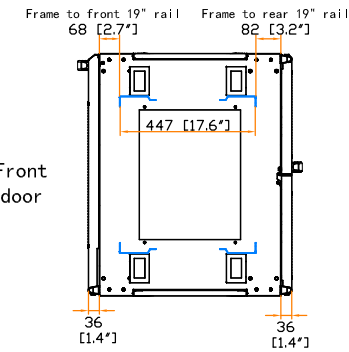
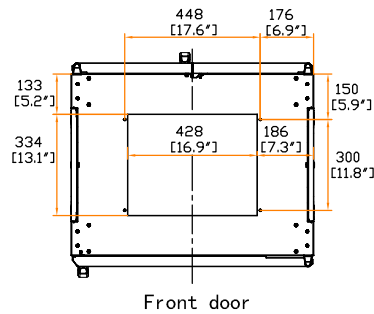
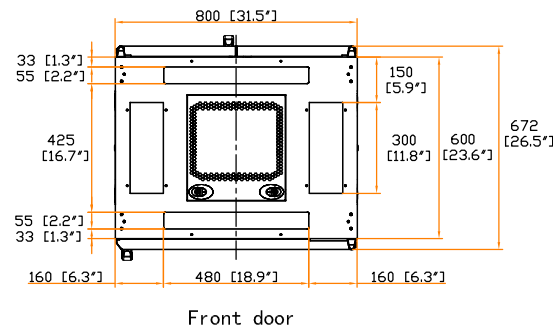

The company reserves the right to modify product specifications without prior notice and assumes no responsibility for any error which may appear in this publication.

Copyright 2020 Austin Hughes Electronics Ltd. All rights reserved.

Dimension (Overall) : 800 ( W ) x 672 ( D ) x 2035 ( H ) mm / 31.5 ( W ) x 26.5 ( D ) x 80.1 ( H ) in.

Dimension (Effective) : 800 ( W ) x 600 ( D ) x 1867 ( H ) mm / 31.5 ( W ) x 23.6 ( D ) x 73.5 ( H ) in.

Net Weight : - kg / - lb

Color : Black (RAL-9005) or White (RAL-9016)

Static Loading : 1000 kg / 2200 lb

Environmental : RoHS3 & REACH compliant by SGS

Unit : mm [ in. ]