

Front view

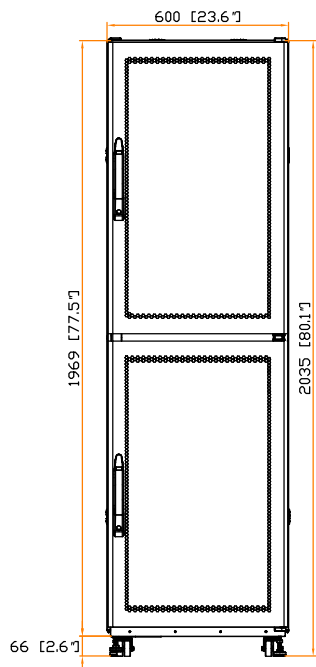

Rear view

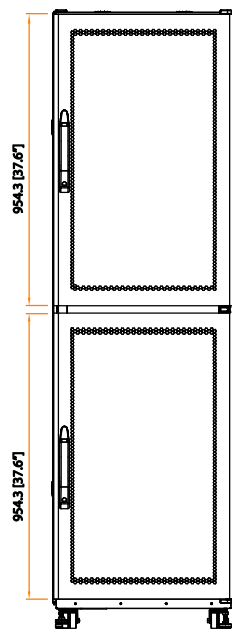

Side view

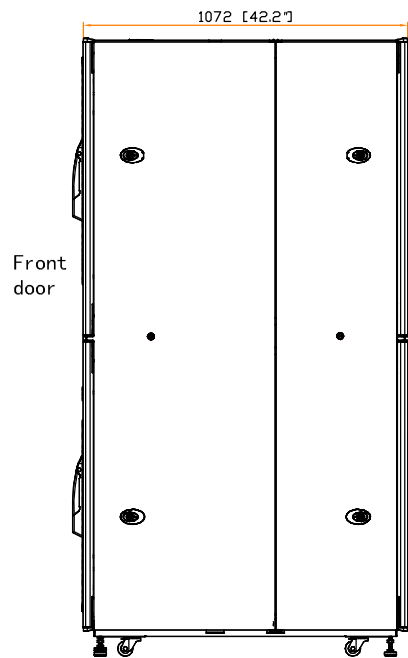

Front view

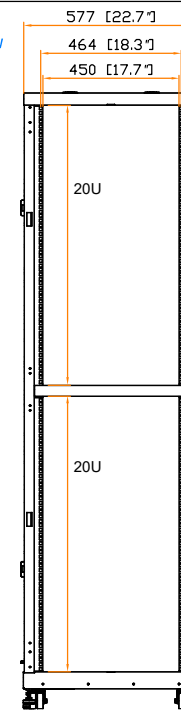

Side view(w/o side panel)

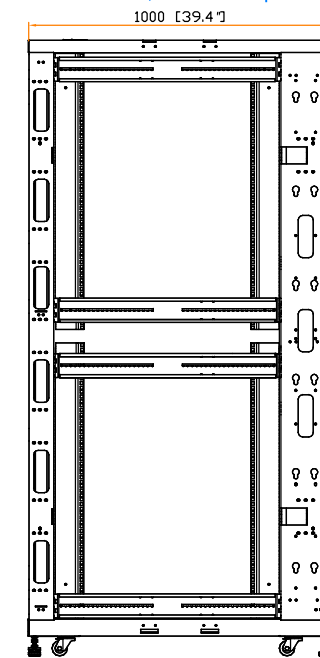

Top view

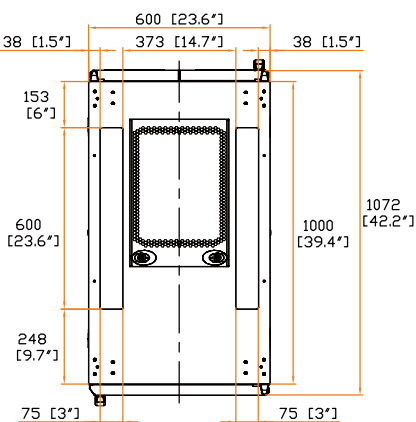

Front door

Bottom view

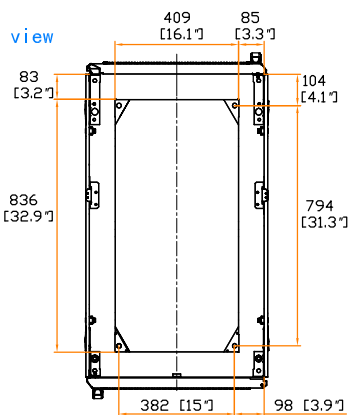

Front door

19"rail position

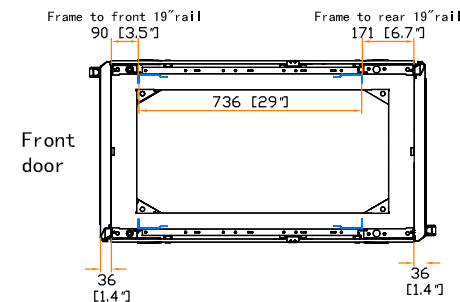

Front door



The company reserves the right to modify product specifications without prior notice and assumes no responsibility for any error which may appear in this publication.

Copyright 2020 Austin Hughes Electronics Ltd. All rights reserved.

Dimension (Overall) : 600 (W) x 1072 (D) x 2035 (H) mm / 23.6 (W) x 42.2 (D) x 80.1 (H) in.

Net Weight : kg / lb

Color : Black (RAL-9005) or White (RAL-9016)

Static Loading : kg / lb

Environmental : RoHS3 & REACH compliant by SGS

Unit : mm [ in. ]