

Front view

Rear view

Side view

Front view

Side view(w/o side panel)

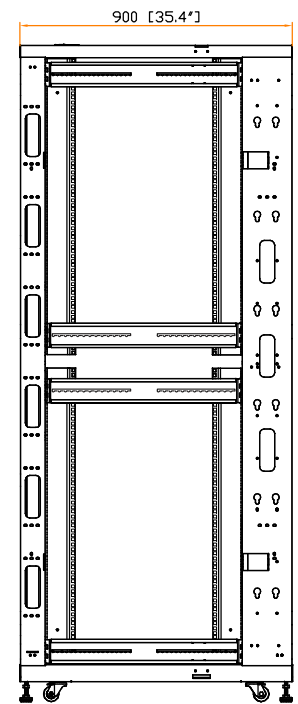
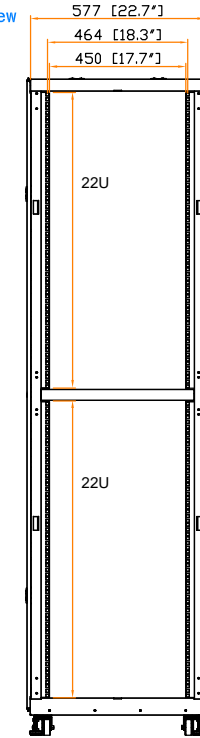
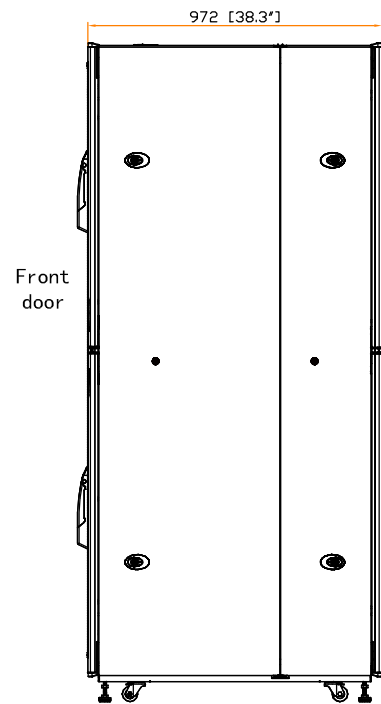
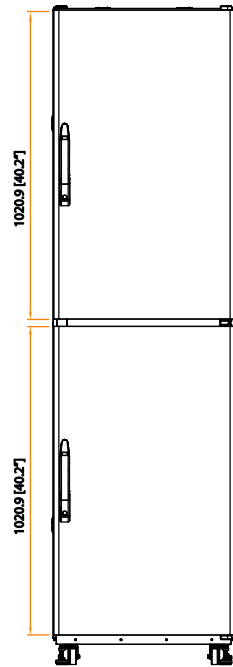
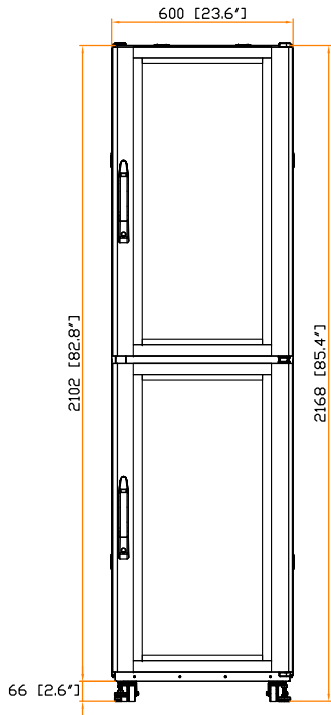

Top view

Bottom view

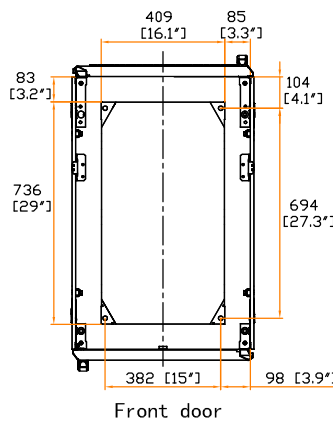
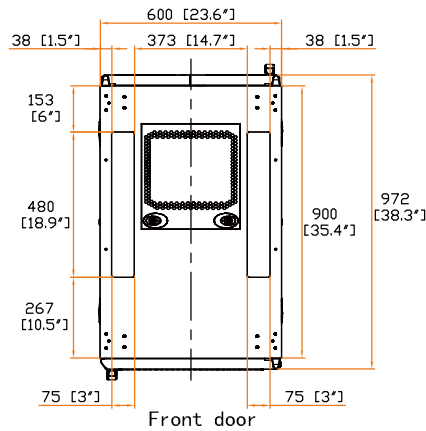

19" rail position

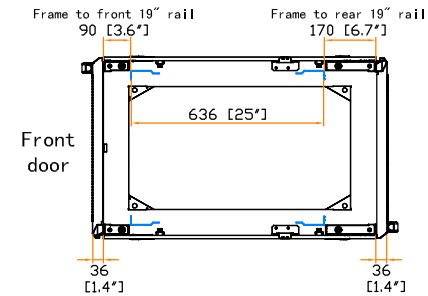

The company reserves the right to modify product specifications without prior notice and assumes no responsibility for any error which may appear in this publication.

Copyright 2020 Austin Hughes Electronics Ltd. All rights reserved.

Dimension (Overall)	:	600 (W) x 972 (D) x 2168 (H) mm / 23.6 (W) x 38.3 (D) x 85.4 (H) in.
Net Weight	:	kg / lb
Color	:	Black (RAL-9005) or White (RAL-9016)
Static Loading	:	kg / lb
Environmental	:	RoHS3 & REACH compliant by SGS

Unit : mm [in.]