

Top view :

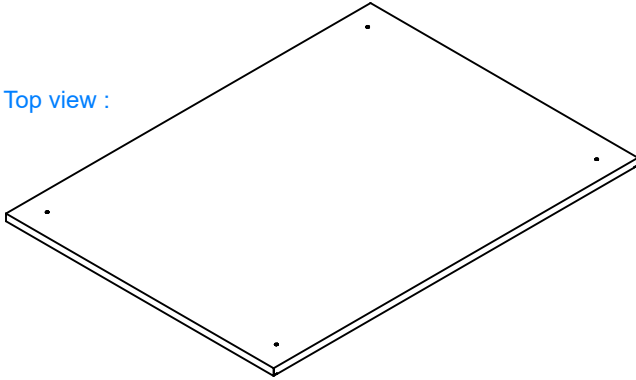

Bottom view :

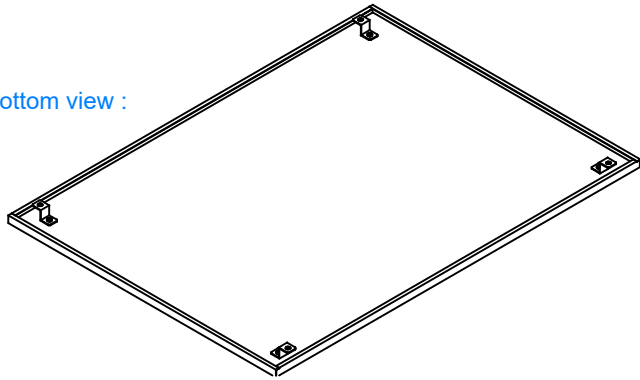

Top view :

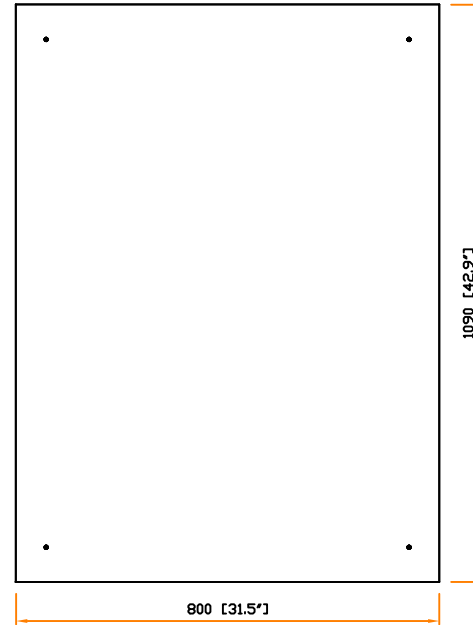

Side view :

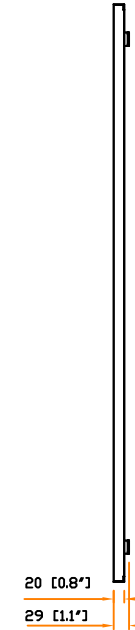

Front view :

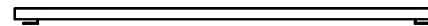

The company reserves the right to modify product specifications without prior notice and assumes no responsibility for any error which may appear in this publication.

Copyright 2020 Austin Hughes Electronics Ltd. All rights reserved.



Design. Manufacturing. Global Services.

Material : Steel
Coating : Powder
Screw : M6 x 10mm screw x 4 & Z bracket x 4
Dimension : 800 (W) x 1090 (D) x 20 (H) mm / 31.5 (W) x 42.9 (D) x 0.8 (H) in.
Color : Black (RAL-9005) or White (RAL-9016)
Gross weight : - kg / - lb
Environmental : RoHS3 & Reach compliant by SGS

