

User Manual 17" / 19" LED-backlit LCD



RKP117 / RKP119

1U LED-backlit LCD Console Drawer

Options :

- AV / DVI-D / HDMI
- DC power



FC

CE



REACH

Designed and manufactured by Austin Hughes

761

Legal Information

First English printing, April 2025

Information in this document has been carefully checked for accuracy; however, no guarantee is given to the correctness of the contents. The information in this document is subject to change without notice. We are not liable for any injury or loss that results from the use of this equipment.

Safety Instructions

Please read all of these instructions carefully before you use the device. Save this manual for future reference.

- Unplug equipment before cleaning. Don't use liquid or spray detergent; use a moist cloth.
- Keep equipment away from excessive humidity and heat. Preferably, keep it in an air-conditioned environment with temperatures not exceeding 40° Celsius (104° Fahrenheit).
- When installing, place the equipment on a sturdy, level surface to prevent it from accidentally falling and causing damage to other equipment or injury to persons nearby.
- When the equipment is in an open position, do not cover, block or in any way obstruct the gap between it and the power supply. Proper air convection is necessary to keep it from overheating.
- Arrange the equipment's power cord in such a way that others won't trip or fall over it.
- If you are using a power cord that didn't ship with the equipment, ensure that it is rated for the voltage and current labelled on the equipment's electrical ratings label. The voltage rating on the cord should be higher than the one listed on the equipment's ratings label.
- Observe all precautions and warnings attached to the equipment.
- If you don't intend on using the equipment for a long time, disconnect it from the power outlet to prevent being damaged by transient over-voltage.
- Keep all liquids away from the equipment to minimize the risk of accidental spillage. Liquid spilled on to the power supply or on other hardware may cause damage, fire or electrical shock.
- Only qualified service personnel should open the chassis. Opening it yourself could damage the equipment and invalidate its warranty.
- If any part of the equipment becomes damaged or stops functioning, have it checked by qualified service personnel.

What the warranty does not cover

- Any product, on which the serial number has been defaced, modified or removed.
- Damage, deterioration or malfunction resulting from:
 - Accident, misuse, neglect, fire, water, lightning, or other acts of nature, unauthorized product modification, or failure to follow instructions supplied with the product.
 - Repair or attempted repair by anyone not authorized by us.
 - Any damage of the product due to shipment.
 - Removal or installation of the product.
 - Causes external to the product, such as electric power fluctuation or failure.
 - Use of supplies or parts not meeting our specifications.
 - Normal wear and tear.
 - Any other causes which does not relate to a product defect.
- Removal, installation, and set-up service charges.

Regulatory Notices Federal Communications Commission (FCC)

This equipment has been tested and found to comply with the limits for a Class A digital device, pursuant to Part 15 of the FCC rules. These limits are designed to provide reasonable protection against harmful interference in business, industrial and commercial environments.

Any changes or modifications made to this equipment may void the user's authority to operate this equipment. This equipment generates, uses, and can radiate radio frequency energy and, if not installed and used in accordance with the instructions, may cause harmful interference to radio communications.

However, there is no guarantee that interference will not occur in a particular installation. If this equipment does cause harmful interference to radio or television reception, which can be determined by turning the equipment off and on, the user is encouraged to try to correct the interference by one or more of the following measures:

- Re-position or relocate the receiving antenna.
- Increase the separation between the equipment and receiver.
- Connect the equipment into an outlet on a circuit different from that to which the receiver is connected.

Contents

< Part. 1 > RKP117

1.1	Package Content	P.1
1.2	Structure Diagram & Dimension	P.1
1.3	Installation	P.3
1.4	Connection	P.5

< Part. 2 > Specifications / OSD

2.1	Product Specifications	P.6
2.2	Keyboard / Mouse Specifications	P.8
2.3	On-screen Display Operation (OSD)	P.9

< Part. 3 > Options

3.1	3G / HD / SD-SDI Broadcast-grade input	P.11
3.2	HDMI, DVI-D, S-Video + BNC	P.12
3.3	DC Power : 12V / 24V / 48V / 125V / 250V	P.13

< Part. 4 > KVM Integration

4.1	RKP117	P.14
-----	--------	------

Before Installation

- It is very important to mount the equipment in a suitable cabinet or on a stable surface.
- Make sure the place has a good ventilation, is out of direct sunlight, away from sources of excessive dust, dirt, heat, water, moisture and vibration.

Unpacking

The equipment comes with the standard parts shown in package content. Check and make sure they are included and in good condition. If anything is missing, or damaged, contact the supplier immediately.

How To Clean Your LCD Monitor



Caution :

- To avoid the risk of electric shock, make sure your hands are dry before unplugging your monitor from or plugging your monitor into an electrical outlet.
- When you clean your monitor, do not press down on the LCD screen. Pressing down on the screen can scratch or damage your display. Pressure damage is not covered under warranty.
- Use only cleansers made specifically for cleaning monitors and monitor screens. Cleansers not made to clean monitors and monitor screens can scratch the LCD display or strip off the finish.
- Do not spray any kind of liquid directly onto the screen or case of your monitor. Spraying liquids directly onto the screen or case can cause damage which is not covered under warranty.
- Do not use paper towels or abrasive pads to clean your monitor. Using an abrasive pad or any wood based paper product such as paper towels can scratch your LCD screen.

Cleaning Your Monitor

To clean your LCD safely, please follow these steps :

- ① Disconnect the power cord.
- ② Gently wipe the surface using a clean, dry microfiber cloth. Use as little pressure as possible.

Cleaning Tough Marks and Smudges

To remove tough marks and smudges, please follow these steps :

- ① Disconnect the power cord.
- ② Spray a small amount of non-abrasive cleanser on a microfiber cloth.



Caution : Do not spray or apply any liquids directly onto the monitor. Always apply the solution to your microfiber cloth first, not directly on the parts you are cleaning.

- ③ Gently wipe the surface. Use as little pressure as possible.
- ④ Wait until your monitor is completely dry before plugging it in and powering it up.

< Part 1 >

< 1.1 > Package Content

RKP117 / RKP119



RKP117 or RKP119 unit X 1

- CB-6A 6ft VGA console cable X 1
- Power cord X 1
- M6 screw, cage nut & cup washer X 8



The above package content is only for the single console models. It varies with options such as KVM, HDMI, DVI-D, AV & DC power.

< 1.2 > Structure Diagram

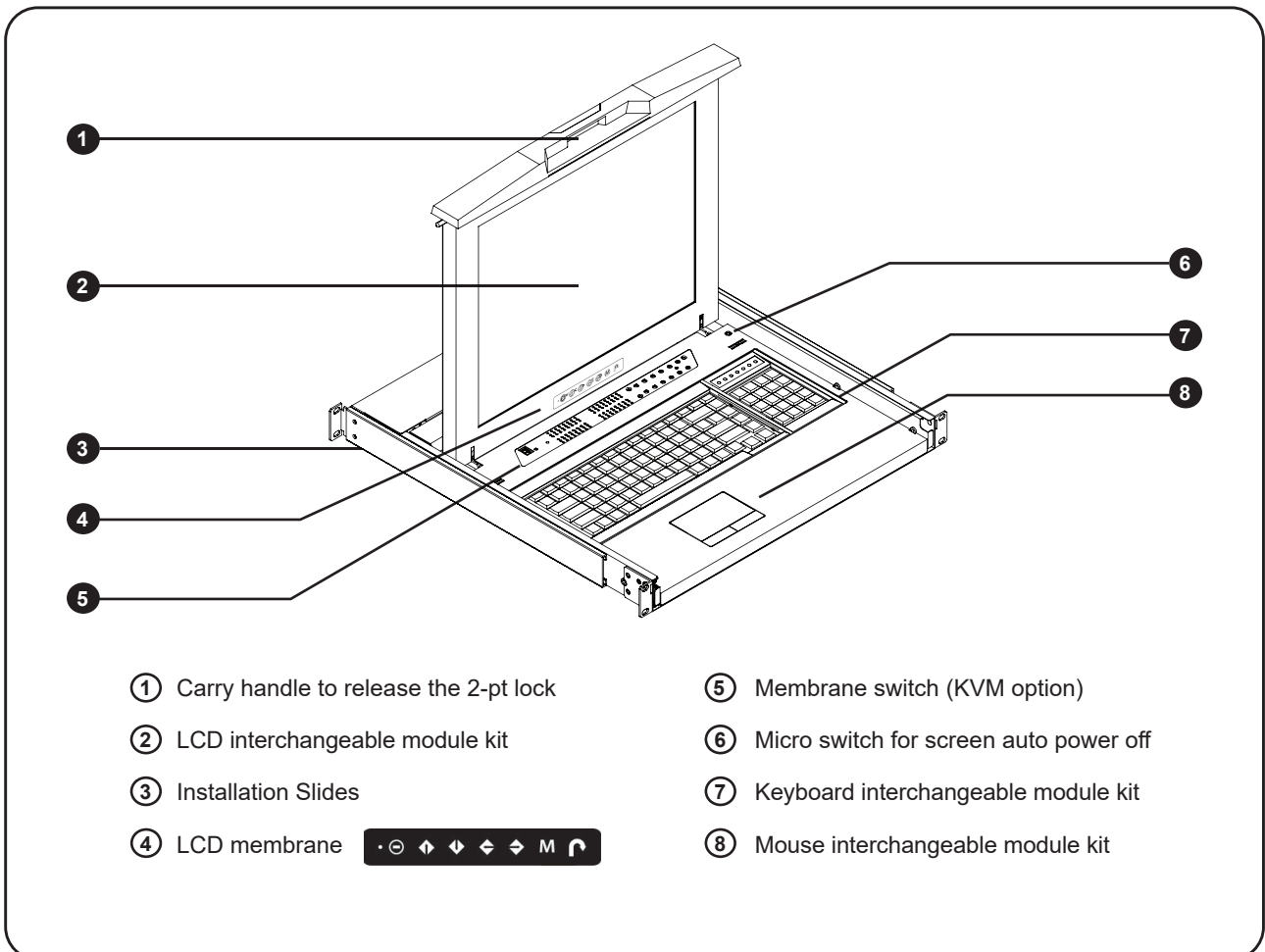

< 1.2 > Dimension

Front View

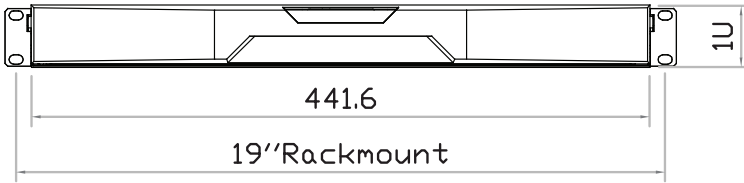

Rear View

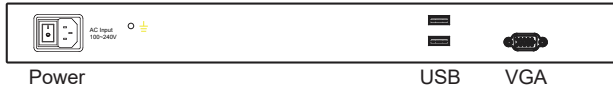

UNIT : mm
1mm = 0.03937 inch

Side View

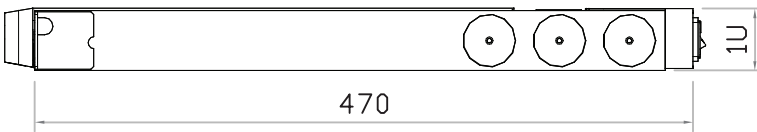

Top View

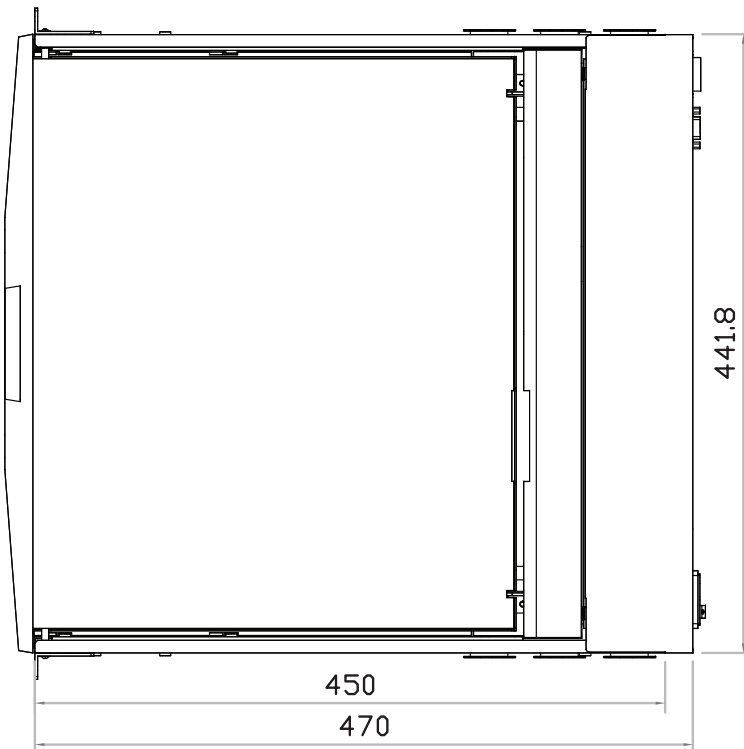

Model	Product Dimension (W x D x H)	Packing Dimension (W x D x H)	Net Weight	Gross Weight
RKP117	441.6 x 470 x 44 mm 17.4 x 18.5 x 1.73 inch	590 x 808 x 140 mm 23.2 x 31.8 x 5.5 inch	12 kg 26.4 lb	16.6 kg 36.5 lb
RKP119	441.6 x 510 x 44 mm 17.4 x 19.7 x 1.73 inch	590 x 808 x 140 mm 23.2 x 31.8 x 5.5 inch	12.7 kg 27.9 lb	17.3 kg 38.1 lb



The weight is only for the single console models. It varies with accessories & options such as KVM, HDMI, DVI-D, AV & DC power.

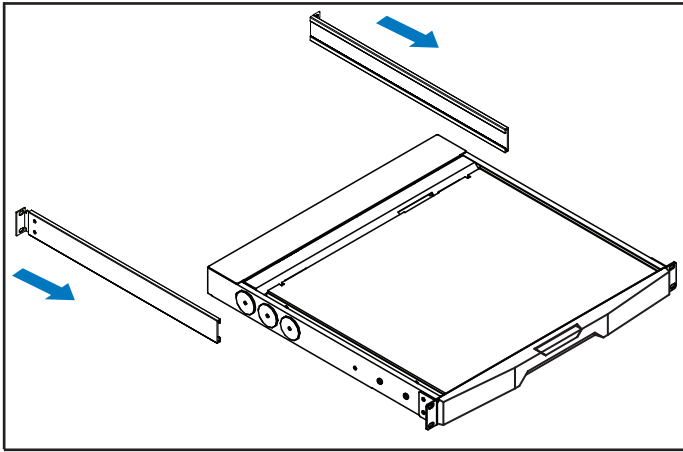

Step 1

- Insert the left and right rear mounting brackets into the LCD console drawer.

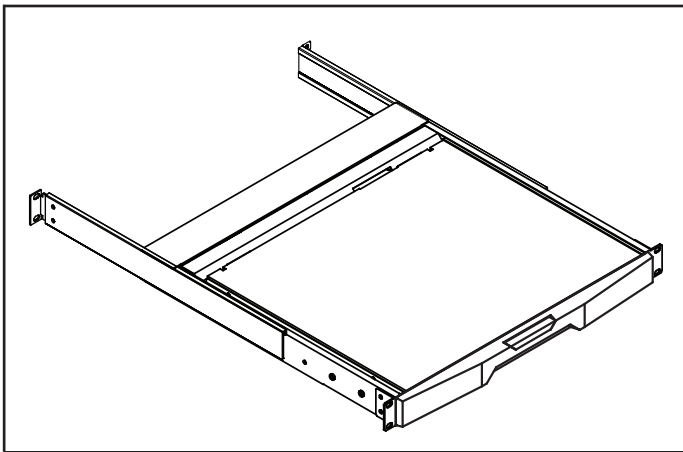

Step 2

- Measure the depth of the front and rear mounting rails.
- Align each rear mounting bracket to a suitable length.

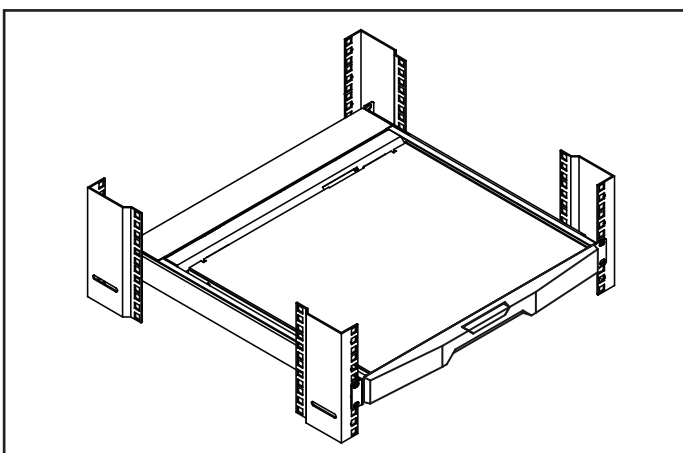

Step 3

Complete the installation

- Fix the LCD console drawer into the rack.

 **M6 screw, cage nut & cup washer x 8 are provided.**

< 1.3 > Installation- How to use the drawer

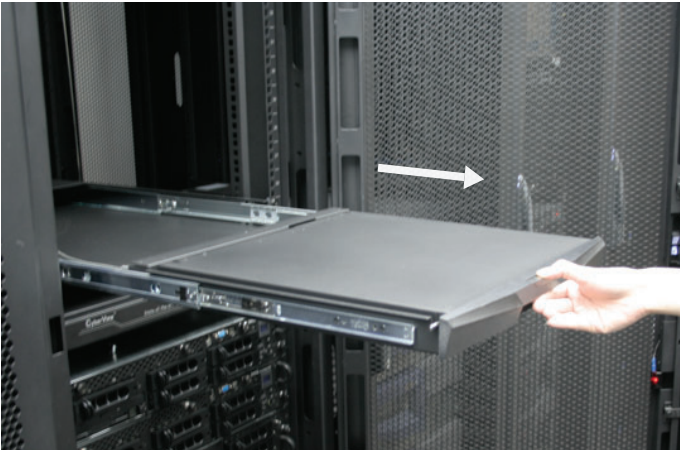

- Press the handle button and slide out the drawer.



- Flip up the LCD to a suitable angle.



- Operate the LCD console drawer.



After use the drawer

Basically, user can push in the drawer back to park position by releasing the left & right slide lock arrow (as long as the drawer starts moving, he/she can release their finger right away, holding the arrow is not necessary).

< 1.4 > Connection to **USB Server** via CB-6A cable RKP117 / RKP119

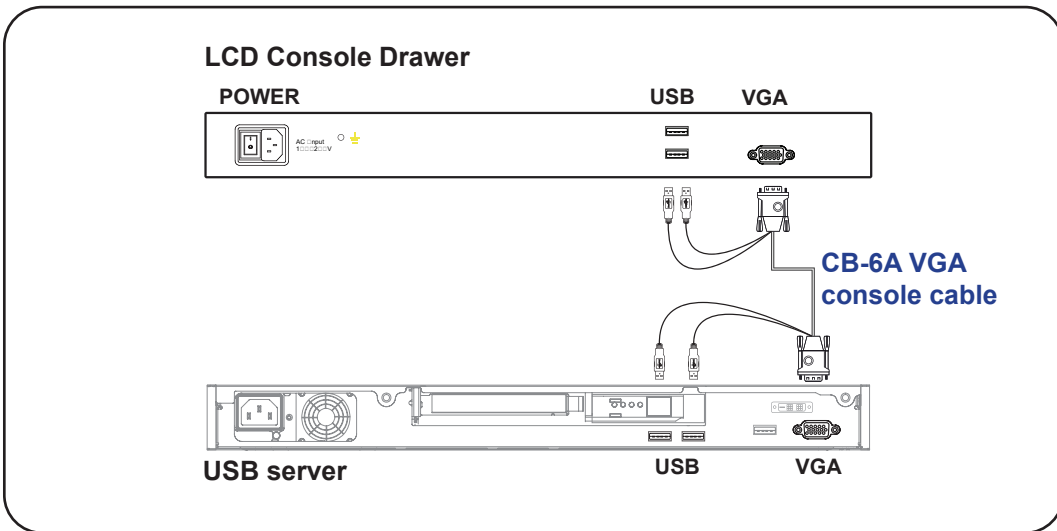

< 1.4 > Connection to **external KVM** via CB-6A cable

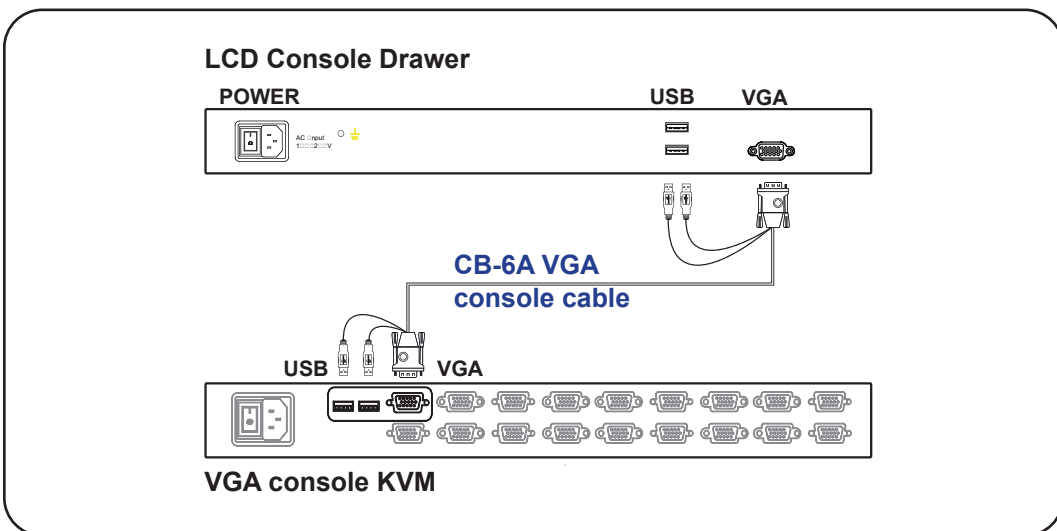

Caution : The LCD console drawer is hot-pluggable, but components of connected devices, such as the servers and KVM switch, may not be hot-pluggable. Plugging and unplugging cables while servers and KVM are powered on may cause irreversible damage to the servers, KVM and LCD console drawer. Before attempting to connect anything to the LCD console drawer, we suggest turning off the power to all devices. Apply power to connected devices again only after the LCD console drawer is receiving power. The company is not responsible for damage caused in this way.

< Part 2 >

< 2.1 > Product Specifications

LED-backlit LCD Panel		RKP117	RKP119
Manufacturer		AUO	AUO
Panel Size (diagonal)		17-inch TFT color LED-backlit LCD	19-inch TFT color LED-backlit LCD
Display pixel (dots x lines)		1280 x 1024	1280 x 1024
Brightness (typ.)		250	250
Contrast Ratio (typ.)		1000:1	1000:1
Color		16.7 M	16.7 M
Viewing Angle (L/R/U/D)		85/85/80/80	85/85/80/80
Response Time (ms)		5	5
Dot pitch (mm)		0.264	0.294
Display Area (mm)		337.92H x 270.33V	376.32H x 270.33V
Surface treatment	Haze 25%, Hard-coating		
Surface hardness	3H		
Backlight Type	LED		
MTBF (hrs)	30,000		

Video Connectivity	Digital	HDMI	HDMI 1.4, HDCP 1.4
		DVI	DVI-D, TMDS single link
	Analog	VGA	Analog 0.7Vp-p
		Composite (BNC)	NTSC & PAL
		S-Video (4-pin)	NTSC & PAL
	Plug & Play	DVI / VGA	VESA EDID structure 1.3
Synchronization	VGA	Separate, Composite & SOG	

Power	Power Supply	Range	Auto-sensing 100 to 240VAC, 50 / 60Hz
		Power Consumption for Single Console	Screen ON
	Power saving mode		Max. 4W
	Power button OFF		Max. 1W
	Power Consumption with KVM integration	Screen ON	Max. 55W
		Power saving mode	Max. 34W

* For details, please refer to our KVM rear kit user manuals

Compliance	EMC	FCC, CE & CCC
	Safety	CE / LVD, UKCA & CCC
	Environmental	RoHS3 & REACH / WEEE

Environmental Conditions	Operating	Temperature	-20 to 65°C degree
		Humidity	10~90%, non-condensing
		Altitude	16,000 ft
	Storage / Non-operating	Temperature	-20 to 65°C degree
		Humidity	5~90%, non-condensing
		Altitude	40,000 ft
		Shock	10G acceleration (11ms duration)
		Vibration	10~300Hz 0.5G RMS random

Physical Specification		RKP117	RKP119
	Product (W x D x H)	441.6 x 470 x 44 mm 17.4 x 18.5 x 1.73 inch	441.6 x 510 x 44 mm 17.4 x 19.7 x 1.73 inch
	Packing (W x D x H)	590 x 808 x 140 mm 23.2 x 31.8 x 5.5 inch	590 x 808 x 140 mm 23.2 x 31.8 x 5.5 inch
	Net Weight	12 kg / 26.4 lb	12.7 kg / 27.9 lb
	Gross Weight	16.6 kg / 36.5 lb	17.3 kg / 38.1 lb

* All dimensions stated are subject to change if options are selected / integrated to base model part codes

Applicable Format	VGA Input	PC Signal	1280 x 1024 x 60 / 75Hz
			1280 x 960 x 60Hz
			1280 x 768 x 60 / 75Hz
			1152 x 864 x 75Hz
			1024 x 768 x 60 / 70 / 75Hz
			848 x 480 x 60Hz
			800 x 600 x 60 / 72 / 75Hz
			720 x 400 x 70Hz
			640 x 480 x 60 / 72 / 75Hz
			640 x 400 x 70Hz
	640 x 350 x 70Hz		
	HDMI Input	PC Signal	Same as VGA
			Video Signal
		Audio Signal	2ch Linear PCM (32 / 44.1 / 48 KHz)
		Speaker	Dual Stereo Speaker, 2 x 2W

< 2.2 > Keyboard / Mouse Specifications

Ge G keyboard integrated with touchpad

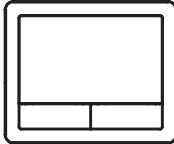
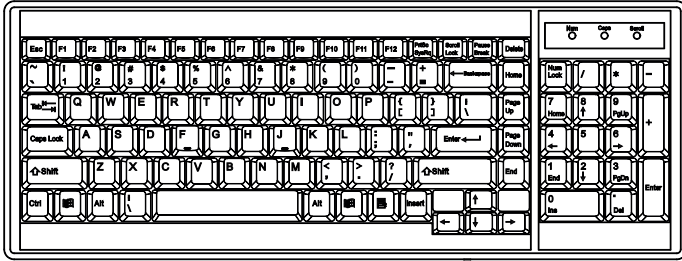

Gb G keyboard integrated with trackball

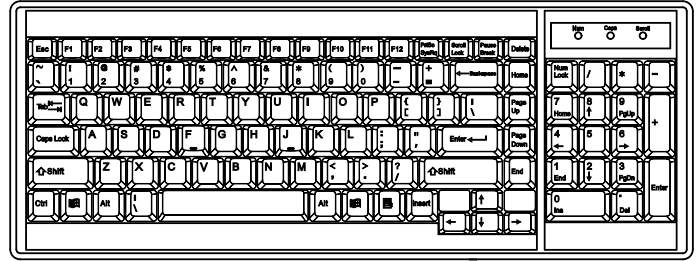

Key force	55 ± 5g
Travelling distance	3 ± 0.3mm
Switch life	> 10 million life cycle time
OS support	Windows / Linux / Unix / Mac OS

Supporting layouts

America



United States

EMEA



United Kingdom



Germany



France



Russia



Spain



Italy

Asia









Japan







Korea

○ Power light
● Green = On
● Orange = Power saving







Membrane Switch	Function
	Power on / off LCD
	Display the OSD menu
	Scrolls through menu options and adjusts the displayed control (To auto adjustment by pressing the button  for 5 seconds)
	Exit the OSD screen Toggle analog, digital & video connection (DVI-D and video options only)

Select another video input (only available for models with multiple video input) :

- (a) Press the button  to call up the on-screen video mode on top right corner.
- (b) Use up/down arrow   to the select the video input
- (c) Press the button  to confirm the selection

< 2.3 > On-screen Display Operation (OSD)

Ver: G56SN20SSTD701
1024 x 768 59.8Hz

Image

Brightness 50

Contrast 50

Color Temp User

Red 255

Green 255

Blue 255

OSD Configuration Page







Image:
for the brightness, contrast, color temp, red, green, and blue



Geometry:
for the auto adjust, H position, V position, phase and clock



Video:
for the colour, tint, sharpness, noise reduction, DCDi and TV Setup



Audio:
for volume, bass, treble, balance, AVL and mute



Misc:
for the language, OSD position, graphic mode, ratio, reset and timer

Adjust: ←→
Select: ↑↓
Set: ●/■
Exit: ↵

< Part 3 >

< 3.1 > Options : 3G / HD / SD-SDI input

RKP117 / RKP119

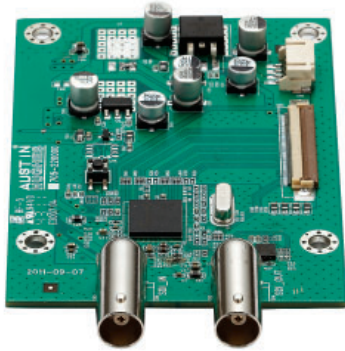

Austin Hughes' SDI input is an ideal solution for the broadcast-grade video and high resolution CCTV market.

Designed for use with CyberView displays, a SDI input module can support up to 1080p @60Hz resolution without using additional space or power and it comes standard with a 2-year warranty.

SDI

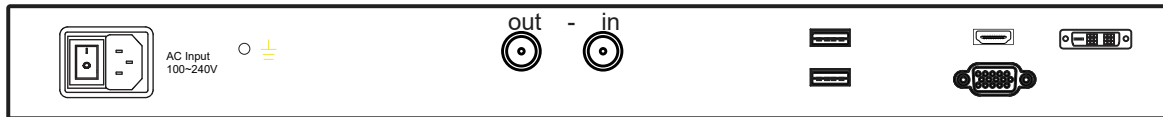

*** For SDI option, RKP117 chassis extension in depth to 530mm (20.9")
RKP119 chassis extension in depth to 570mm (22.4")

INPUT	3G-SDI IN	BNC x 1 / 0.8Vp-p (75 ohm)
	3G-SDI OUT	BNC x 1 / Active through, equalized & relocked

Standard Compliance	Video	SMPTE 425M / 274M / 296M / 125M ITU-R BT.656
	Audio	SMPTE 299M / 272M-C

Compatible Video Format	3G-SDI	1080p @60 / 50Hz, 4:2:2
		1080p @30 / 25 / 24Hz, 4:4:4
		1080i @60 / 50Hz, 4:4:4
		720p @60 / 50Hz, 4:4:4
	HD-SDI	1080p @30 / 25 / 24Hz, 4:2:2
		1080i @60 / 50Hz, 4:2:2
		720p @60 / 50Hz, 4:2:2
	SD-SDI	480i @60Hz, 4:2:2
	ITU-R BT.656	576i @50Hz, 4:2:2

Compatible Audio Format	3G-SDI	48kHz, 16 / 20 / 24 bit, 2 CH, Synchronized Video
	HD-SDI	48kHz, 16 / 20 / 24 bit, 2 CH, Synchronized Video
	SD-SDI	48kHz, 16 / 20 / 24 bit, 2 CH, Synchronized / Asynchronized Video

Max. Transmission Distance 75 ohm coaxial cable	3G-SDI	150m at 2.97Gb/s
	HD-SDI	250m at 1.485Gb/s
	SD-SDI	480m at 270Mb/s

< 3.2 > Options :

AV4.4 Option

- HDMI (HDMI 1.4, HDCP 1.4)
- DVI-D (DVI-D TMDS single link)
- Audio input & output

HDMI Option

- HDMI (HDMI 1.4, HDCP 1.4)
- DVI-D (DVI-D TMDS single link)

BNC Option

- BNC (S-Video + Composite, BNC)

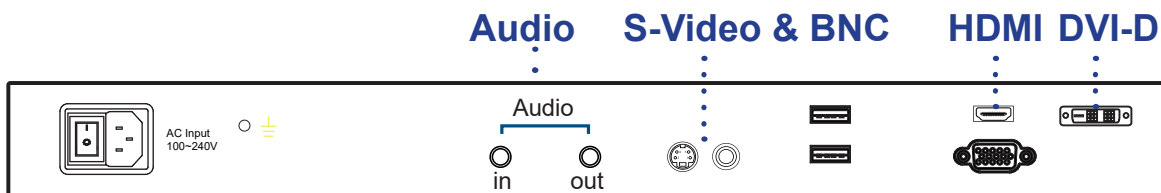

For the above options,

RKP117 depth will be extended from 470mm (18.5") to 540mm (21.3");

RKP119 depth will be extended from 510mm (20.1") to 580mm (22.8")

< 3.2 > Options : DC Power

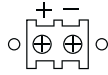

RKP117 / RKP119

Model	12V	24V	48V	125V	250V
Input rating					
Input voltage:	12-Volt	24-Volt	48-Volt	110-Volt	300-Volt
Input range:	9 ~ 18V	18 ~ 36V	36 ~ 75V	66 ~ 160V	180 ~ 425V
Input current					
- No load	50 mA	50 mA	50 mA	35 mA	10 mA
- Full load	4950 mA	2450 mA	1220 mA	749 mA	600 mA
Output rating					
Output voltage:	12-Volt	12-Volt	12-Volt	12-Volt	12-Volt
Output current:	4.16A	4.16A	4.16A	6.25A	12.5A
Efficiency	84%	85%	85%	91%	86%

DC power





*** For DC power option :



- (1) If the unit with LCD, **earthing** may be required 
- (2) DC option excludes AC power adapter and power cord.
- (3) RKP117 depth will be extended from 470mm (18.5") to 540mm (21.3") ;
RKP119 depth will be extended from 510mm (20.1") to 580mm (22.8")

< Part. 4 > KVM Integration



www.austin-hughes.com/support/usermanual/cyberview/UM-CV-HDMIKVM-KIT.pdf

HDMI KVM 	Local	Remote		8-port	-	-
	0	0	0	-801K	-	-



www.austin-hughes.com/support/usermanual/cyberview/UM-CV-DVIKVM-KIT.pdf

DVI-D KVM 	Local	Remote		12-port	-	-
	1	0	0	-1201D	-	-



www.austin-hughes.com/support/usermanual/cyberview/UM-CV-MUKVM-KIT.pdf

Cat6 Matrix KVM 	Local	Remote		8-port	16-port	32-port
	1	1	1	-	-MUIP1613	-MUIP3213
	1	1	2	-	-MUIP1624	-MUIP3224
	1	1	0	-	-MU1602	-MU3202
	1	2	0	-	-MU1603	-MU3203
1	3	0	-	-MU1604	-MU3204	



www.austin-hughes.com/support/usermanual/cyberview/UM-CV-UKVM-KIT.pdf

Cat6 Combo KVM 	Local	Remote		8-port	16-port	32-port
	1	0	1	-UIP802	-UIP1602	-UIP3202
	1	1	0	-U802	-U1602	-U3202
1	0	0	-U801	-U1601	-U3201	



www.austin-hughes.com/support/usermanual/cyberview/UM-CV-MKVM-KIT.pdf

DB-15 Matrix KVM 	Local	Remote		8-port	16-port	32-port
	1	1	1	-MIP813	-MIP1613	-
	1	1	2	-MIP824	-MIP1624	-
	1	1	0	-M802	-M1602	-
	1	2	0	-M803	-M1603	-
1	3	0	-M804	-M1604	-	

www.austin-hughes.com/support/usermanual/cyberview/UM-CV-SKVM-KIT.pdf

DB-15 Combo KVM 	Local	Remote		8-port	16-port	32-port
	1	0	1	-IP802	-IP1602	-
	1	1	0	-802	-1602	-
1	0	0	-S801	-S1601	-	

www.austin-hughes.com/support/usermanual/cyberview/UM-CV-USBKVM-KIT.pdf

DB-15 USB Hub KVM 	Local	Remote		8-port	16-port	32-port
	1	0	1	-IP802H	-IP1602H	-
	1	1	0	-802H	-1602H	-
1	0	0	-801H	-1601H	-	

Model	Product Dimension (W x D x H)	Packing Dimension (W x D x H)	Net Weight	Gross Weight
RKP117 with KVM	441.6 x 590 x 44 mm 17.4 x 23.2 x 1.73 inch	590 x 808 x 140 mm 23.2 x 31.8 x 5.5 inch	13 kg 28.6 lb	19 kg 41.8 lb
RKP119 with KVM	441.6 x 630 x 44 mm 17.4 x 24.4 x 1.73 inch	590 x 808 x 140 mm 23.2 x 31.8 x 5.5 inch	13.7 kg 30.1 lb	19.7 kg 43.3 lb

The company reserves the right to modify product specifications without prior notice and assumes no responsibility for any error which may appear in this publication.

All brand names, logo and registered trademarks are properties of their respective owners.

Copyright 2025 Austin Hughes Electronics Ltd. All rights reserved.