

Front view

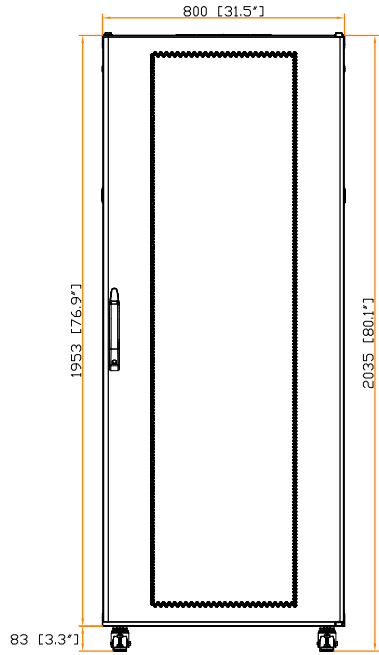

Rear view

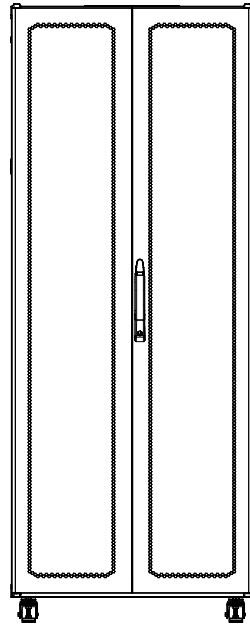

Side view

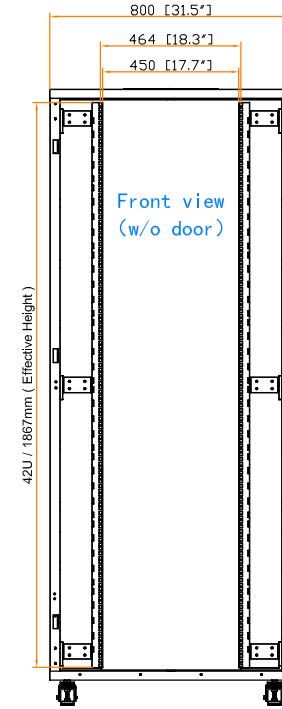
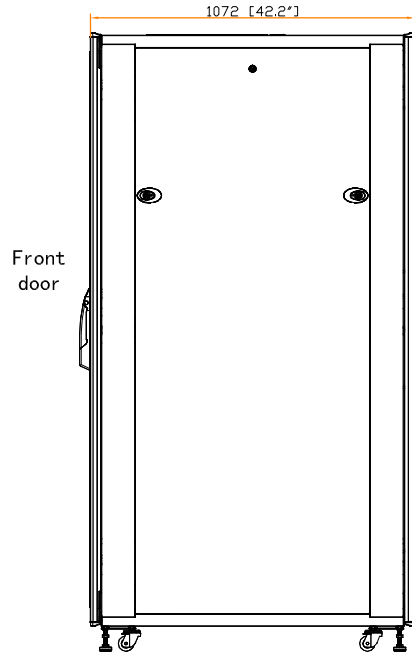

Side view(w/o side panel)

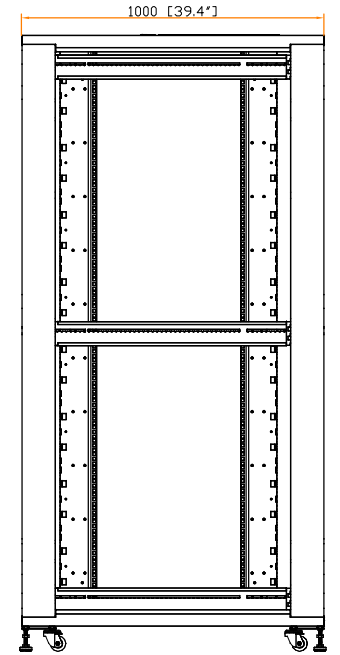

Top view

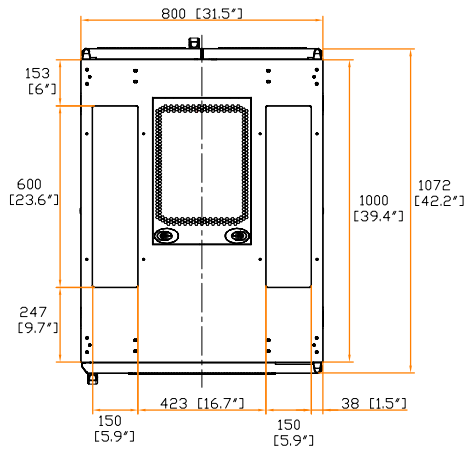

Bottom view

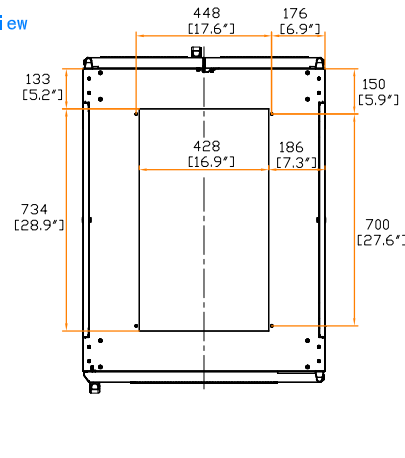

19" rail position

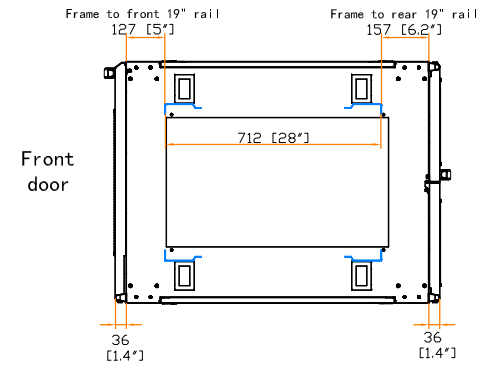

The company reserves the right to modify product specifications without prior notice and assumes no responsibility for any error which may appear in this publication.

Copyright 2021 Austin Hughes Electronics Ltd. All rights reserved.

Dimension (Overall) : 800 (W) x 1072 (D) x 2035 (H) mm / 31.5 (W) x 42.2 (D) x 80.1 (H) in.

Dimension (Effective) : 800 (W) x 1000 (D) x 1867 (H) mm / 31.5 (W) x 39.4 (D) x 73.5 (H) in.

Net Weight : - kg / - lb

Color : Black (RAL-9005) or White (RAL-9016)

Static Loading : 1000 kg / 2200 lb

Environmental : RoHS3 & REACH compliant by SGS

Unit : mm [in.]