

Front view

Rear view

Side view

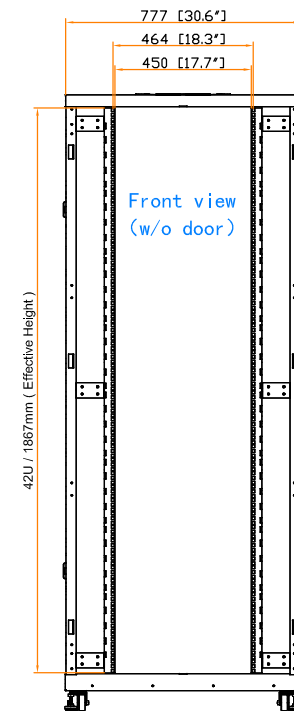

Side view(w/o side panel)

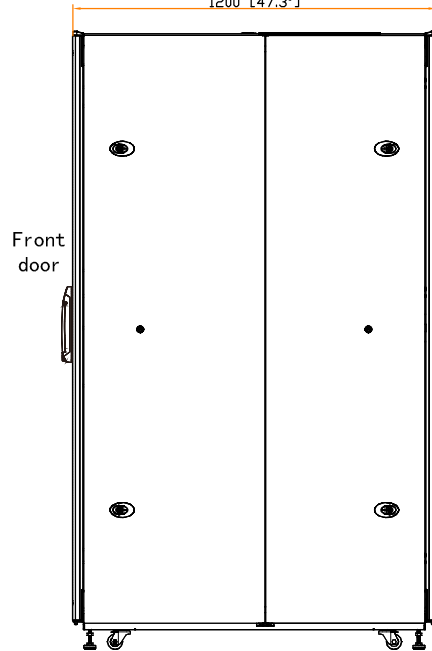
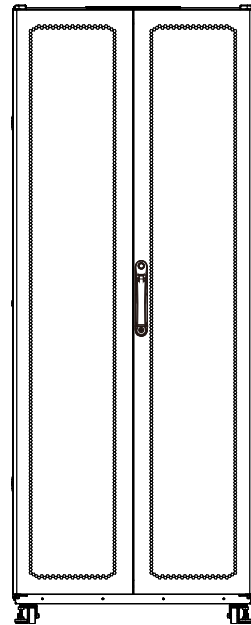
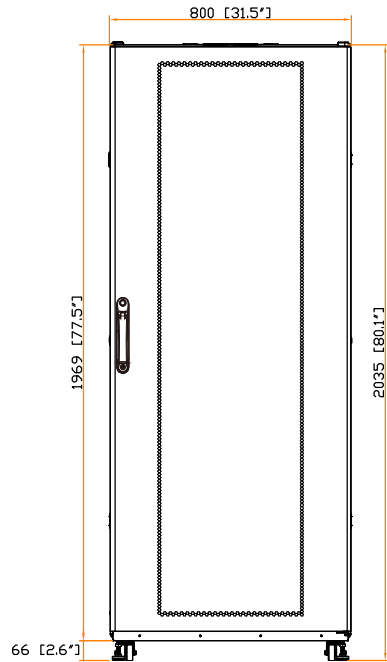
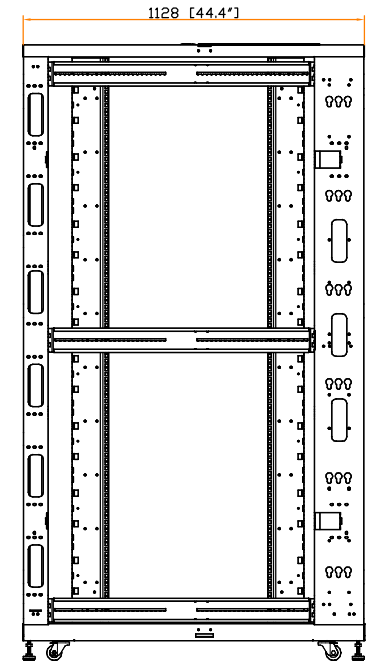

Top view

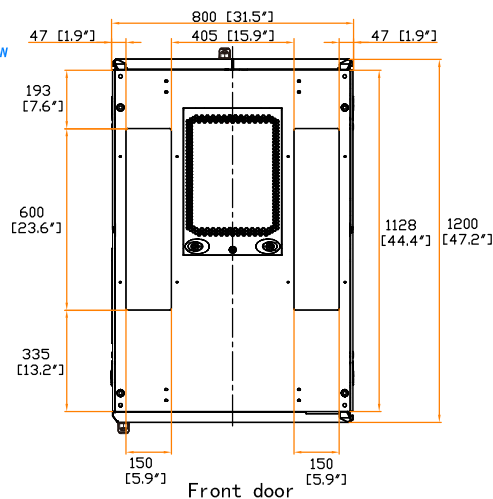

Bottom view

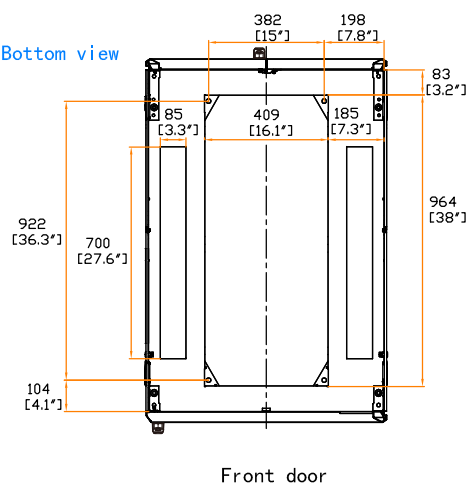

19" rail position

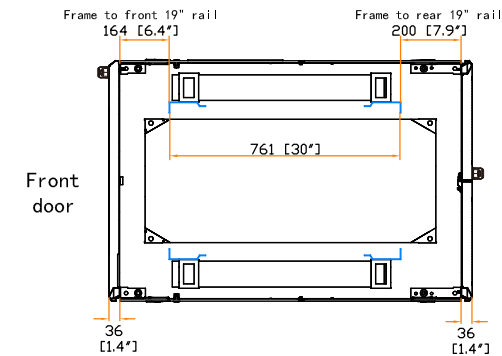

The company reserves the right to modify product specifications without prior notice and assumes no responsibility for any error which may appear in this publication.

Copyright 2021 Austin Hughes Electronics Ltd. All rights reserved.

Dimension (Overall)	: 800 (W) x 1200 (D) x 2035 (H) mm / 31.5 (W) x 47.2 (D) x 80.1 (H) in.
Dimension (Effective)	: 777 (W) x 1128 (D) x 1867 (H) mm / 30.6 (W) x 44.4 (D) x 73.5 (H) in.
Net Weight	: - kg / - lb
Color	: Black (RAL-9005) or White (RAL-9016)
Static Loading	: 1500 kg / 3300 lb
Environmental	: RoHS3 & REACH compliant by SGS

Unit : mm [in.]