

10" professional display chassis drawing

6mm aluminum front bezel

Model : AP-10 / HAP-10

unit : mm

Front View

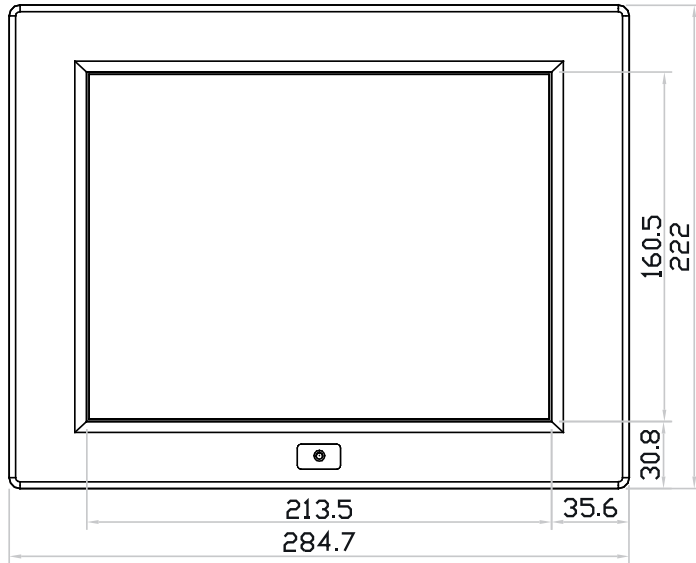

Left-side View

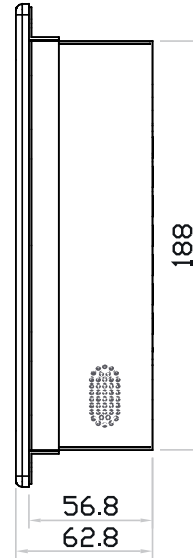

Rear View

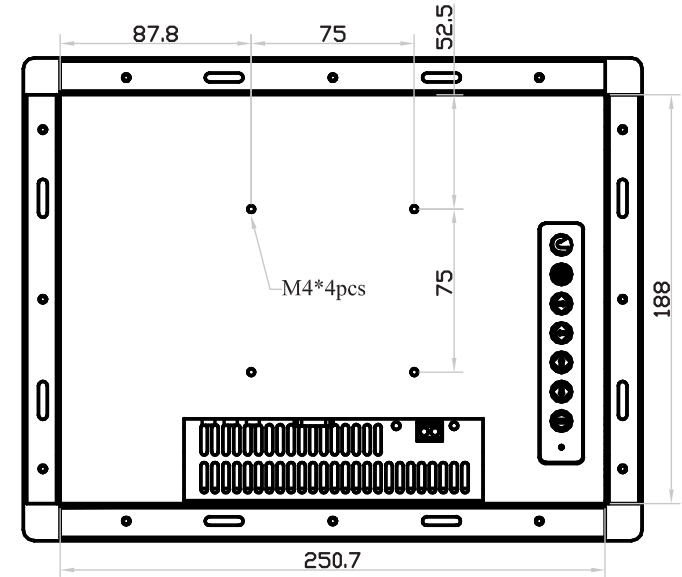

Bottom View

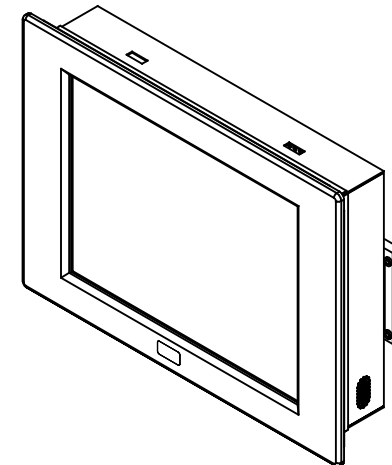
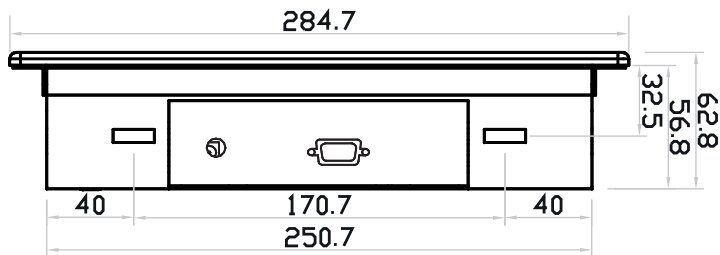

10" professional display chassis drawing

6mm aluminum front bezel with NEMA 4 / IP65 front protection

Model : NAP-10 / NHAP-10

unit : mm

Front View

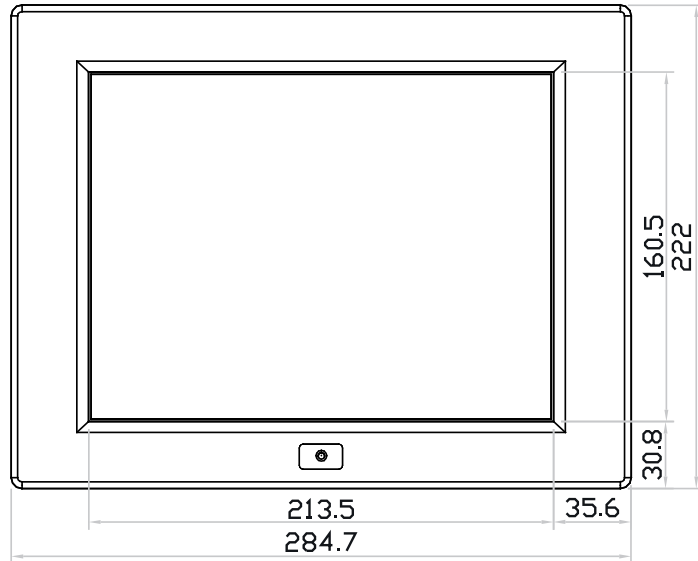

Left-side View

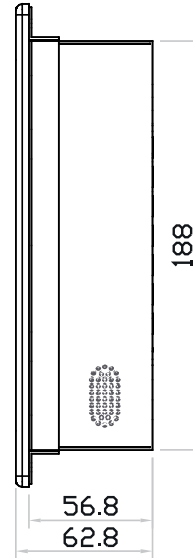

Rear View

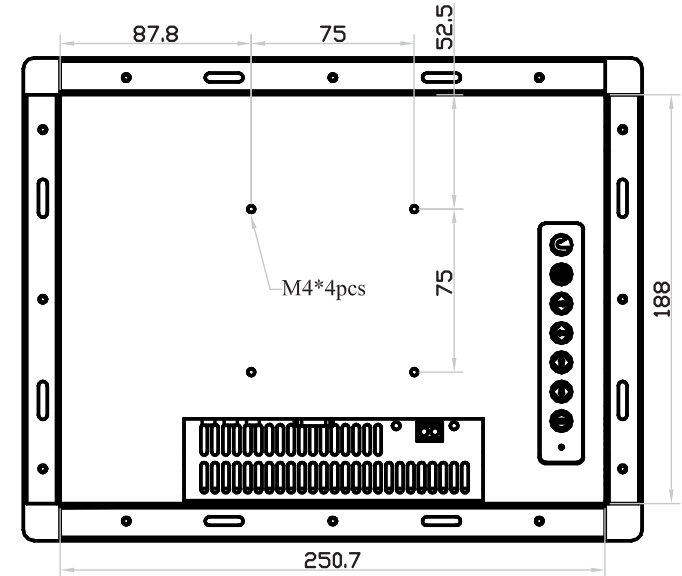

Bottom View

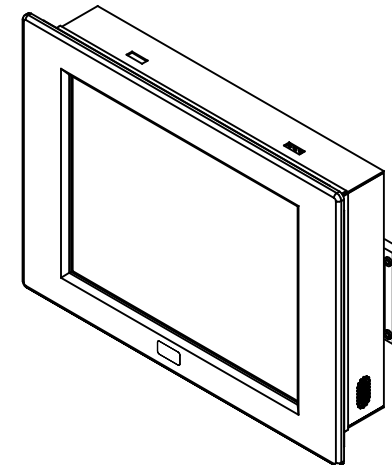
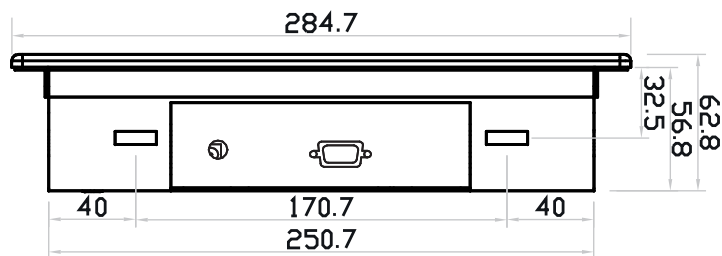

10" professional display chassis drawing

Universal open frame

Model : OP-10 / HOP-10

UltraView

unit : mm

Front View

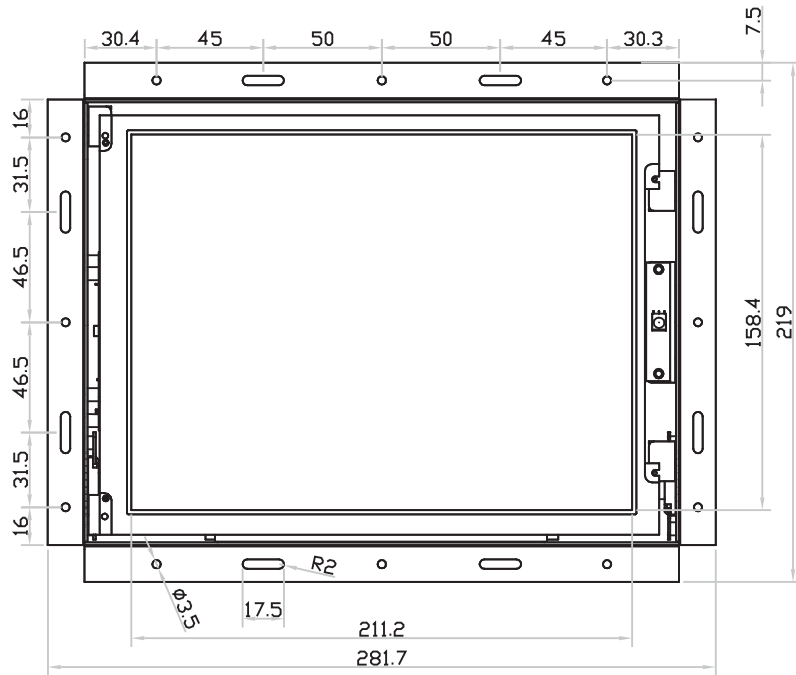

Left-side View

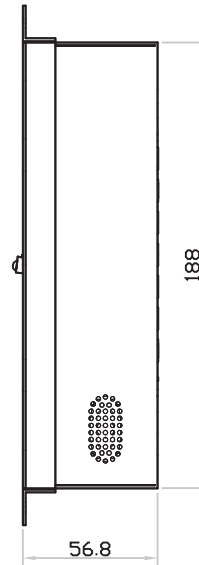

Rear View

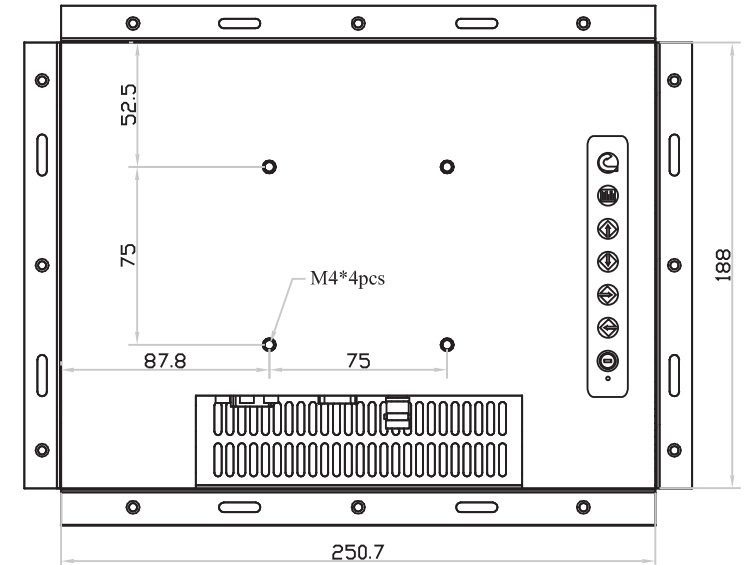

Bottom View

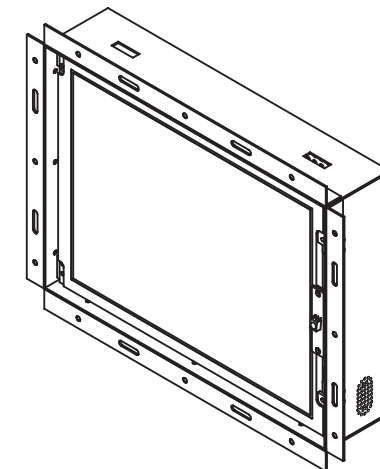
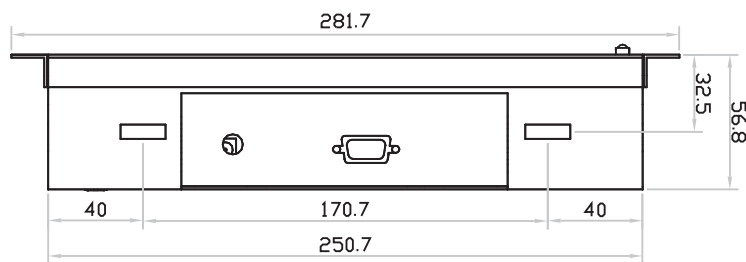

10" professional display chassis drawing

Aluminum front cover

Model : DP-10 / HDP-10



unit : mm

Front View

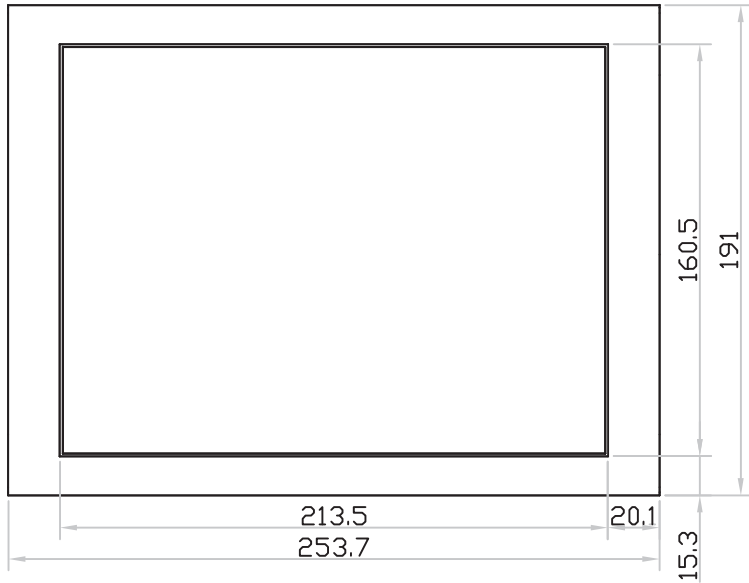

Left-side View

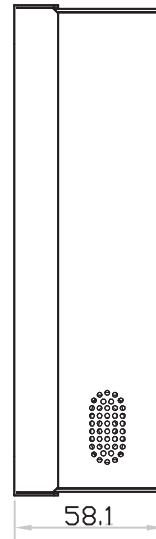

Rear View

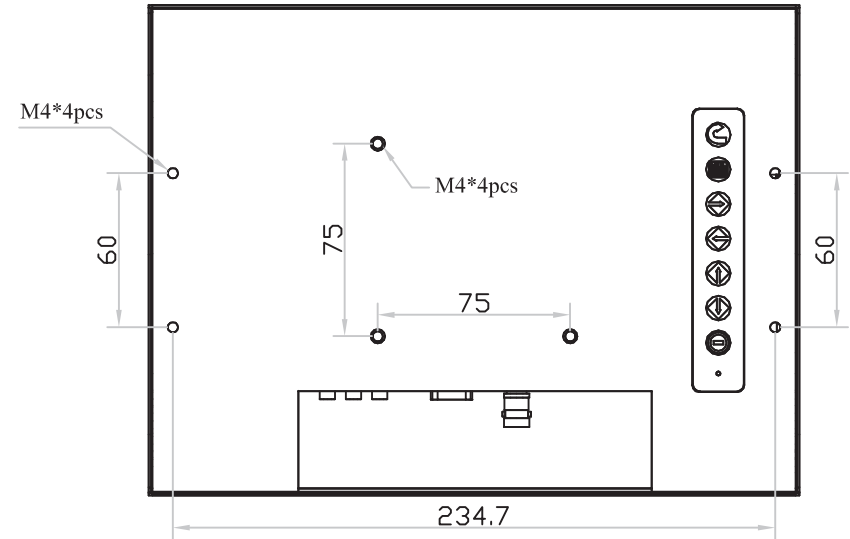

Bottom View

